

Adjustable Pitch Vaneaxial Fans

Series 65

Series 65C

Series 66

Series 67

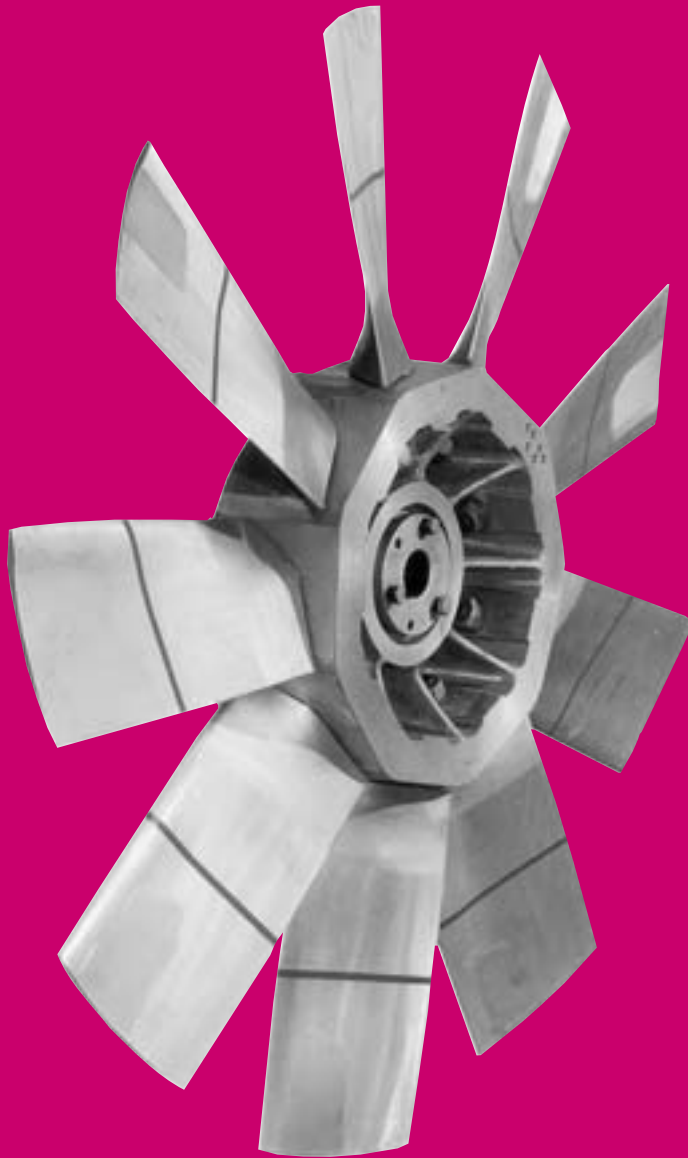
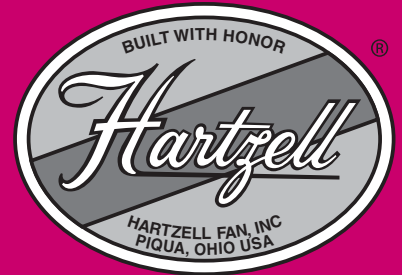

HARTZELL®

Hartzell Fan, Inc., Piqua, Ohio 45356
www.hartzellfan.com

Bulletin A-142-K May 2009

Index

Model Code Explanation Page 2
Features Page 3
Drive and Mounting Arrangements Page 4
Installation Weights –
Bearing/Shaft Sizes. Page 5
Selection Guide Pages 6-7
Construction Features –
Series 65 and 65C Page 8

Dimensions – Series 65 and 65C Page 9
Performance Data –
Series 65 and 65C Pages 10-19
Construction Features – Series 66. Page 20
Construction Features – Series 67. Page 21
Performance Data –
Series 66 and 67 Pages 22-25
Options & Accessories Pages 26-27



Certified Ratings for Air and Sound

Hartzell Fan, Inc. certifies that the Series 65C, Direct Drive, Adjustable Pitch Vaneaxial Fan, C-Faced Motor and the Series 66, Belt Drive, Adjustable Pitch Vaneaxial Fan shown hereon, are licensed to bear the AMCA seal for air and sound. The ratings shown are based on tests and procedures performed in accordance with AMCA Publication 211 and AMCA Publication 311 and comply with the requirements of the AMCA Certified Ratings Program.

Certificates of Design Assessment are issued by the American Bureau of Shipping. The assessment is a representation by the Bureau as to the degree of compliance the design exhibits with applicable sections of the Rules. The certificates, by itself, do not reflect that the products are Type Approved.

Sound Performance data is available upon request. Please contact the factory and ask for Engineering Publication #SD-142.



Hartzell Fan, Inc. certifies that the Adjustable Pitch Vaneaxial Blowers, Series 65, shown on pages 8 and 10 through 19, are authorized to bear CE Marking in accordance with Machinery Safety Directive 98/37/EC of the European Union. Reference Technical File E.S. 13.2.1.

Hartzell Model Explanation

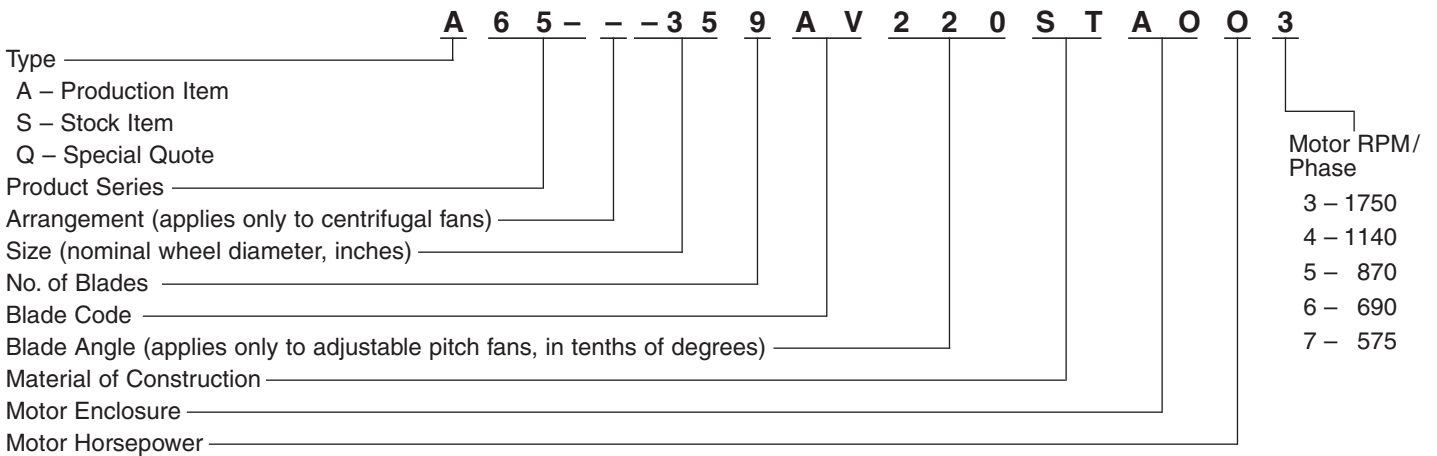

Motor Horsepower

Horsepower	1	1½	2	3	5	7½	10	15	20	25	30	40	50	60	75	100	125	150	200
Code Letter	H	I	J	K	L	M	N	O	P	Q	R	S	T	U	V	W	X	Y	Z

Example:

Assume a performance of 22,500 CFM at 2" S.P.W.G., at standard conditions is required. Reading Rating Curve on page 10, we find Series 65 Adjustable Pitch Vane Axial Fans with a 35" blade diameter and a performance of 23,000 CFM at 2" S.P.; 1750 RPM with a 12.0 BHP. In looking at our Model Code, we

see this fan has 9 blades, type AV, with a blade angle of 22°. The fan is constructed of steel and has a Totally Enclosed, Air Over motor enclosure. Motor horsepower required is 15, therefore, horsepower code is "O." Motor RPM required is 1750, therefore, motor RPM code is "3."

This bulletin lists Hartzell's complete line of Adjustable Pitch Vaneaxial Fans and accessories. More than 70 Hartzell offices can provide specific performance and installation data to meet your requirements. Call your Hartzell representative for assistance. Visit our website (www.hartzellfan.com) or call toll-free for the name of your Hartzell representative...

1-800-336-3267



Features

Adjustable Pitch Vaneaxial Fans

The adjustable pitch vaneaxial fan offers an axial flow fan to the Hartzell product line. The design features adjustable pitch blades in a wide range of sizes, both direct drive and belt driven.

The adjustable pitch vaneaxial is designed to meet the needs of industry for a space and energy saving unit that offers a wide range of performance and quiet operation. The design and manufacture of the Hartzell adjustable pitch vaneaxial fan will provide you with the same dependable service you have grown accustomed to with other Hartzell products.

Advantages of adjustable pitch vaneaxial fans

- The flexibility of the adjustable pitch vaneaxial is its major advantage over the standard fixed pitch vaneaxial or centrifugal. The feature provides for future changes in capacity-pressure requirements on the system. The design eliminates the need for larger size V-belt fans.
- The cost of axial fans is generally much less than centrifugal equipment.
- The high total efficiency of adjustable pitch vaneaxial fans provides comparable efficiency to most centrifugal units and generally higher levels than in-line centrifugal fans. The input energy of the system is therefore comparable, or less than, centrifugal units. Coupled with lower initial capital investment, large savings can be realized.

- The compact design of the adjustable pitch vaneaxial provides appreciable savings in space. The unit can be installed directly into the system with the same inlet and discharge dimensions.
- Simple blade adjustment to provide for changes in capacity-pressure requirements.
- Eliminates the need for costly multi-speed motors.
- The comparative light weight of the adjustable pitch vaneaxial offers savings in lower freight costs and installation costs due to the ease and speed of installation.
- Ease of maintenance on direct drive units is of particular importance. There are fewer moving parts – maintenance of V-belt drives and bearings is eliminated. Should the unit require maintenance, the fan housing can easily be slipped from the system.
- If protection from corrosive atmospheres is required, coating costs are much less for axial flow fans than centrifugal units.
- Should sound attenuation be required, it is much easier and less costly to attenuate an adjustable pitch vaneaxial than a centrifugal unit.

The Hartzell adjustable pitch vaneaxial fan combines varied concepts of design and engineering techniques. The result is a fan that can be designed to match the requirements of a system, providing savings on the initial investment, installation and operation of the equipment.



Blade Adjustment

The adjustable pitch vaneaxial blade can be quickly adjusted without removing the wheel from the motor shaft. The design features a blade shank with a tapered, conical section. The tapered section fits into a conical pocket in the hub, providing a taper lock fit. A bolt is cast into the blade, projecting into the hub and is secured on the inside by a lockwasher and nut. Assembly is provided with a blade pitch index for assistance in adjusting blade angle settings.



Drive Arrangements

Arrangement #4

For direct drive. Wheel overhung on motor shaft. Motor supported within casing. For vertical, horizontal or inclined mounting positions.



Arrangement #9

For belt drive, wheel overhung on a shaft supported by bearings mounted within casing. Designed for mounting of motor on outside of casing. For vertical, horizontal or inclined mounting positions.

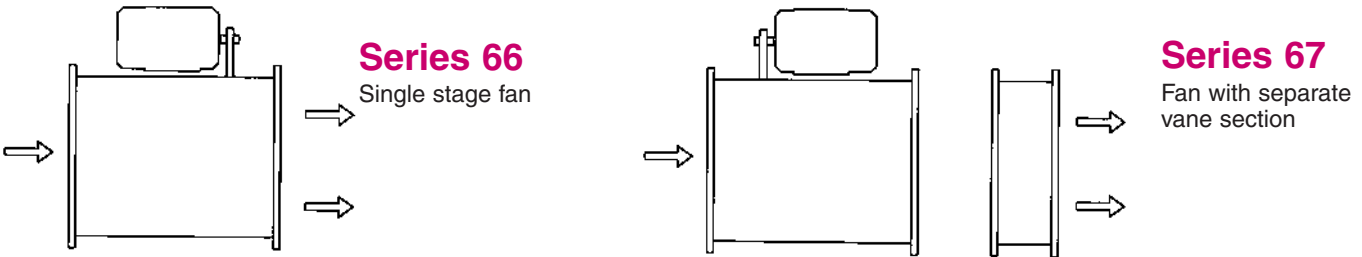

Mounting Arrangements

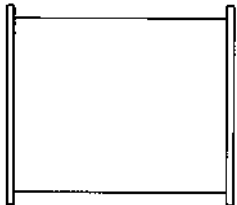

Duct Mounting

Inlet and discharge flanges allow direct mounting to duct work, providing the duct system is structured to support the unit. Can be mounted in the vertical, horizontal or inclined position.

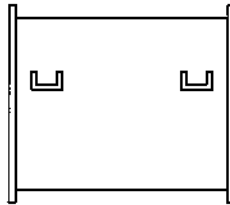

Ceiling Suspension

Side-angle supports enable suspension of unit from the ceiling. Can be used with vibration isolators. Also available for vertical mountings.

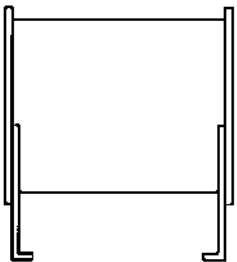

Mounting Feet

Bolted to the inlet and discharge flange, mounting feet allow positioning of the unit on the floor, ceiling, wall or platform. Can be used with vibration isolators.

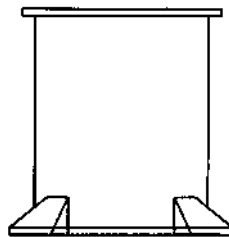

Floor Mounting

Alternate method of mounting fans in vertical position. Brackets ensure rigid, flush mounting of fan to floor. Specify vertical up or vertical down air flow.

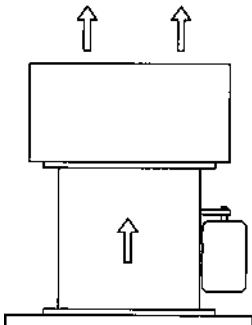

Roof Mounting

When desirable, the belt driven Vaneaxial fan can be mounted as a roof exhauster. Together with a stack cap and panel, the three elements combine to provide a roof exhauster unit with high static pressure capabilities. Back draft dampers offer weatherproof closure for vertical air discharge.

CFM Limitation for Damper Operation

CFM	FAN SIZE			
	35"	39"	44"	49"
Minimum	8800	10900	13600	17000
Maximum	21700	26700	33600	41900

CFM	FAN SIZE			
	57"	63"	71"	79"
Minimum	22800	27800	35200	43600
Maximum	56200	68400	86700	107200

For performance, refer to the appropriate Vaneaxial Rating Table, allowing 1/8" SP resistance for the stack cap. Minimum velocity required through stack cap for damper operation is 1300 FPM, maximum is 3200 FPM.



Installation Weights – Bearing/Shaft Sizes

Size	Motor HP	Shaft/Brg Size (Series 66/67)	Estimated Maximum Installation Weight (less motor and options)			
			65	65C	66	67
35	1	1 ³ / ₁₆	545	362	766	1054
	1 1/2	1 ³ / ₁₆				
	2	1 ³ / ₁₆				
	3	1 ³ / ₁₆ - 1 ¹¹ / ₁₆	543	370	780	1071
	5	1 ³ / ₁₆ - 2 ⁷ / ₁₆				
	7 1/2	1 ¹¹ / ₁₆ - 2 ⁷ / ₁₆	617	370	813	1108
	10	1 ¹¹ / ₁₆ - 2 ⁷ / ₁₆				
	15	1 ¹⁵ / ₁₆ - 2 ⁷ / ₁₆				
	20	1 ¹⁵ / ₁₆ - 2 ⁷ / ₁₆				
	25	1 ¹⁵ / ₁₆ - 2 ⁷ / ₁₆	610	369	797	1089
	30	1 ¹⁵ / ₁₆				
	40	1 ¹⁵ / ₁₆	685			
	50	1 ¹⁵ / ₁₆				
	60	1 ¹⁵ / ₁₆				
75	1 ¹⁵ / ₁₆					
39	1	1 ³ / ₁₆	795	419	886	1260
	1 1/2	1 ³ / ₁₆				
	2	1 ³ / ₁₆	793	427	900	1277
	3	1 ³ / ₁₆ - 1 ¹¹ / ₁₆				
	5	1 ³ / ₁₆ - 2 ⁷ / ₁₆				
	7 1/2	1 ¹¹ / ₁₆ - 2 ⁷ / ₁₆	879	427	932	1313
	10	1 ¹¹ / ₁₆ - 2 ⁷ / ₁₆				
	15	1 ¹⁵ / ₁₆ - 2 ⁷ / ₁₆				
	20	1 ¹⁵ / ₁₆ - 2 ⁷ / ₁₆				
	25	1 ¹⁵ / ₁₆	873	426	917	1295
	30	1 ¹⁵ / ₁₆				
	40	1 ¹⁵ / ₁₆	965			
	50	1 ¹⁵ / ₁₆				
	60	1 ¹⁵ / ₁₆				
75	1 ¹⁵ / ₁₆					
44	2	1 ¹¹ / ₁₆	1032	604	1295	1796
	3	1 ¹¹ / ₁₆				
	5	1 ¹¹ / ₁₆ - 2 ⁷ / ₁₆	1133	603	1356	2042
	7 1/2	1 ¹¹ / ₁₆ - 2 ⁷ / ₁₆				
	10	1 ¹¹ / ₁₆ - 2 ⁷ / ₁₆				
	15	2 ³ / ₁₆ - 2 ⁷ / ₁₆	1127	603	1375	1877
	20	2 ³ / ₁₆ - 2 ⁷ / ₁₆				
	25	2 ³ / ₁₆				
	30	2 ³ / ₁₆				
	40	2 ³ / ₁₆	1239	602	1434	1941
	50	2 ³ / ₁₆				
	60	2 ³ / ₁₆ - 2 ¹¹ / ₁₆	1222		1434	1941
	75	2 ³ / ₁₆ - 2 ¹¹ / ₁₆				
	100	2 ¹¹ / ₁₆				
100	2 ¹¹ / ₁₆	1203				
49	3	1 ¹¹ / ₁₆	1436	665	1372	1953
	5	1 ¹¹ / ₁₆ - 2 ⁷ / ₁₆				
	7 1/2	1 ¹¹ / ₁₆ - 2 ⁷ / ₁₆	1429	664	1433	2018
	10	2 ³ / ₁₆ - 2 ⁷ / ₁₆				
	15	2 ³ / ₁₆ - 2 ⁷ / ₁₆				
	20	2 ³ / ₁₆ - 2 ⁷ / ₁₆				
	25	2 ³ / ₁₆	1619	663	1485	2038
	30	2 ³ / ₁₆				
	40	2 ³ / ₁₆	1604		1515	2106
	50	2 ³ / ₁₆				
	60	2 ³ / ₁₆				
	75	2 ¹⁵ / ₁₆	1581			
	100	2 ¹⁵ / ₁₆				
	125					
150						
200						
200		1618				

Size	Motor HP	Shaft/Brg Size (Series 66/67)	Estimated Maximum Installation Weight (less motor and options)			
			65	65C	66	67
57	3	1 ¹¹ / ₁₆ - 2 ⁷ / ₁₆	1841	1141	2049	3043
	5	1 ¹¹ / ₁₆ - 2 ⁷ / ₁₆				
	7 1/2	2 ³ / ₁₆ - 2 ⁷ / ₁₆	1835	1140	2062	3053
	10	2 ³ / ₁₆ - 2 ⁷ / ₁₆				
	15	2 ³ / ₁₆ - 2 ⁷ / ₁₆	2069	1139	2130	3132
	20	2 ³ / ₁₆				
	25	2 ³ / ₁₆	2053	1164	2140	3142
	30	2 ³ / ₁₆				
	40	2 ³ / ₁₆				
	50	2 ³ / ₁₆ - 2 ¹¹ / ₁₆				
	60	2 ¹¹ / ₁₆	2034			
	75	2 ¹¹ / ₁₆				
	100	2 ¹¹ / ₁₆	2088			
	125	2 ¹¹ / ₁₆				
	150	2 ¹⁵ / ₁₆				
	200	2 ¹⁵ / ₁₆				
63	3	2 ⁷ / ₁₆	2049	1246	2232	3339
	5	2 ⁷ / ₁₆				
	7 1/2	2 ³ / ₁₆ - 2 ⁷ / ₁₆	2043	1245	2235	3339
	10	2 ³ / ₁₆ - 2 ⁷ / ₁₆				
	15	2 ³ / ₁₆ - 2 ⁷ / ₁₆	2305	1244	2319	3434
	20	2 ³ / ₁₆				
	25	2 ³ / ₁₆	2292	1269	2389	3511
	30	2 ³ / ₁₆				
	40	2 ³ / ₁₆ - 2 ¹¹ / ₁₆				
	50	2 ³ / ₁₆ - 2 ¹¹ / ₁₆				
	60	2 ¹¹ / ₁₆	2274			
	75	2 ¹¹ / ₁₆				
	100	2 ¹¹ / ₁₆ - 3 ¹ / ₁₆	2341		2335	3450
	125	2 ¹¹ / ₁₆ - 3 ¹ / ₁₆				
	150	2 ¹⁵ / ₁₆ - 3 ¹ / ₁₆				
	200	2 ¹⁵ / ₁₆				
71	7 1/2	2 ⁷ / ₁₆	3633		3629	5540
	10	2 ⁷ / ₁₆				
	15	2 ⁷ / ₁₆	3936	1958	3688	5609
	20	2 ⁷ / ₁₆				
	25	2 ⁷ / ₁₆	3925	1999	3743	5672
	30	2 ⁷ / ₁₆				
	40	2 ⁷ / ₁₆	3908		3837	5774
	50	2 ⁷ / ₁₆ - 2 ¹⁵ / ₁₆				
	60	2 ⁷ / ₁₆ - 2 ¹⁵ / ₁₆	3991	1996	4282	
	75	2 ⁷ / ₁₆ - 3 ¹ / ₁₆				
	100	2 ¹⁵ / ₁₆ - 3 ¹ / ₁₆				
	125	2 ¹⁵ / ₁₆ - 3 ¹ / ₁₆	4282			
	150	2 ¹⁵ / ₁₆ - 3 ¹ / ₁₆				
	200	2 ¹⁵ / ₁₆ - 3 ¹ / ₁₆				
	79	10	2 ⁷ / ₁₆	4343	2145	3940
15		2 ⁷ / ₁₆				
20		2 ⁷ / ₁₆	4332	2186	4004	6096
25		2 ⁷ / ₁₆				
30		2 ⁷ / ₁₆	4316		4059	6159
40		2 ⁷ / ₁₆ - 2 ¹⁵ / ₁₆				
50		2 ⁷ / ₁₆ - 2 ¹⁵ / ₁₆	4413	2183	4153	6262
60		2 ⁷ / ₁₆ - 2 ¹⁵ / ₁₆				
75		2 ⁷ / ₁₆ - 3 ¹ / ₁₆				
100		2 ⁷ / ₁₆ - 3 ¹ / ₁₆	4745			
125		2 ¹⁵ / ₁₆ - 3 ¹ / ₁₆				
150		2 ¹⁵ / ₁₆ - 3 ¹ / ₁₆				
200		2 ¹⁵ / ₁₆ - 3 ¹ / ₁₆				

Note: Series 66/67 shaft size is dependent on blade angle and speed.



Selection Guide

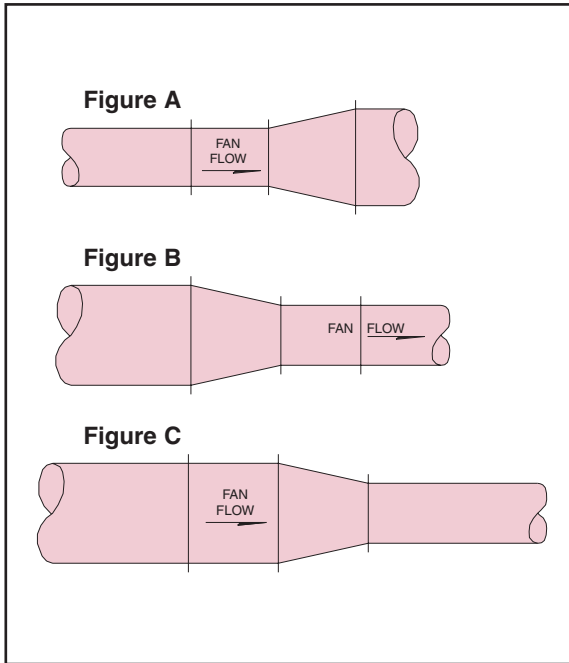

Discharge Cones

Ratings shown in this bulletin are for Vaneaxial Blowers with inlet and outlet ducts of the same diameter as the blower. Discharge cones may be used on the fan to adapt to larger diameters. (See Fig. A). This results in a static pressure regain.

Table 2 shows the amount of additional static pressure capability which results from using the discharge cone. Add the amount of $.45 (VP_1 - VP_2)$ to the unit's static pressure.

$$SP_2 = SP_1 + .45 (VP_1 - VP_2)$$

Thus a blower selected for 4000 FPM O.V. at 2" SP using a size 18" - 21" cone, the static pressure capability would be $2" + .207" = 2.207"$ static pressure. Static pressure regain calculations are approximate and are not part of the AMCA Certified Ratings. Discharge cones may also be used to transform large ducts to the duct fan's inlet size (see Fig. B).

Since these cones have gently tapered sides, the friction loss is negligible, or about $.08 \times$ the difference in velocity pressures. (See Table 1). If the blower is to be used with ducts smaller in diameter than the blower (see Fig. C), the difference in velocity pressure across the cone must be added to the pressure for which the blower is selected.

How to use capacity tables

1. Select fan size, RPM, blade angle and BHP of Blower.
2. If temperature or altitude is involved, correct to standard air density. (See Table 3.) Temperature is limited to 350° F. for aluminum wheels.
3. Vaneaxial performance ratings are based on standard air conditions: sea level, 70° F. and 29.92 in barometric pressure giving an air density of .075 lbs. per cu. ft. The specific gravity of air equals 1.00 at these conditions.

Altitude – Temperature correction – Table 3

Temperatures above or below 70° at sea level (0 ft.) are read vertically between the double lines, giving the proper correction factors. Any other factors are obtained by reading down to the desired temperature, then across to the desired altitude.

EXAMPLE: Assume the required performance to be 54,000 CFM, 3.75 SP, 70° F and 5000 ft. altitude:

1. Table 3 gives a factor of 1.2.
2. $3.75" \text{ SP} \times 1.20 = 4.50" \text{ SP}$ for 70° F at sea level.
3. Series 65 direct drive unit, 49" fan diameter selected from the rating tables for the new conditions. Show 54,000 CFM 4.50" SP at 1750 RPM with 60.0 BHP and 22° blade angle.
4. Correct the horsepower and pressure in Step 3 to non-standard performance by dividing by the factor:
 $4.50" \text{ SP} \div 1.20 = 3.75" \text{ SP}$
 $60.0 \text{ BHP} \div 1.20 = 50.0 \text{ BHP}$
5. Final performance of the Series 65 blower, 49" fan diameter at assumed conditions:
 54,000 CFM, 3.75" SP, 1750 RPM
 50.0 BHP, 22° blade angle
 70° F and 5000 ft. altitude

Table 1

Corresponding Air Velocities for Various Pressures in inches of water (air weight: .07488 lbs. per cu. ft.)			
F.P.M. VELOCITY	PRESSURE INCHES	F.P.M. VELOCITY	PRESSURE INCHES
500	0.156	2250	.316
600	.0225	2500	.391
700	0.305	2750	.473
800	0.400	3000	.562
900	.0504	3250	.661
1000	.0625	3500	.768
1100	.0758	3750	.880
1200	.0900	4000	1.000
1300	.106	4250	1.130
1400	.122	4500	1.265
1500	.141	4750	1.410
1600	.160	5000	1.560
1700	.181	5250	1.720
1800	.203	5500	1.890
1900	.226	5750	2.060
2000	.250	6000	2.250

Table 2 Additional Static Pressure Capability (Regain) Inches W.G.

F.P.M. VELOCITY	PRESSURE INCHES	F.P.M. VELOCITY	PRESSURE INCHES	F.P.M. VELOCITY	PRESSURE INCHES
1000	.012	2750	.099	4500	.261
1250	.020	3000	.117	4750	.290
1500	.029	3250	.138	5000	.323
1750	.040	3500	.160	5250	.356
2000	.052	3750	.183	5500	.392
2250	.065	4000	.207	5750	.428
2500	.081	4250	.233	6000	.467

Note: For 25 – 30° included cone angle.

Table 3 Combined Altitude — Temperature Correction Factors

ALT. FT. / F. TEMP	0	1000	2000	3000	4000	5000	6000	7000	8000	9000	10000	11000	12000
-50	0.77	0.80	0.83	0.86	0.89	0.92	0.96	1.00	1.04	1.08	1.12	1.16	1.21
-25	0.82	0.85	0.89	0.92	0.95	0.98	1.03	1.07	1.11	1.15	1.20	1.24	1.29
0	0.87	0.90	0.94	0.97	1.01	1.04	1.09	1.13	1.17	1.22	1.27	1.31	1.37
25	0.91	0.95	0.98	1.02	1.06	1.09	1.14	1.18	1.23	1.27	1.33	1.37	1.43
50	0.96	1.00	1.04	1.08	1.11	1.15	1.20	1.25	1.30	1.34	1.40	1.45	1.51
70	1.00	1.04	1.08	1.12	1.16	1.20	1.25	1.30	1.35	1.40	1.46	1.51	1.57
100	1.06	1.10	1.14	1.19	1.23	1.27	1.33	1.38	1.43	1.48	1.55	1.60	1.66
125	1.10	1.14	1.19	1.23	1.28	1.32	1.38	1.43	1.49	1.54	1.61	1.66	1.73
150	1.15	1.20	1.24	1.29	1.33	1.38	1.44	1.50	1.55	1.61	1.68	1.74	1.81
175	1.20	1.25	1.30	1.34	1.39	1.44	1.50	1.56	1.62	1.68	1.75	1.81	1.88
200	1.25	1.30	1.35	1.40	1.45	1.50	1.56	1.63	1.69	1.75	1.83	1.89	1.96
225	1.29	1.34	1.39	1.44	1.50	1.55	1.61	1.68	1.74	1.81	1.88	1.95	2.03
250	1.34	1.39	1.45	1.50	1.55	1.61	1.68	1.74	1.81	1.88	1.96	2.02	2.10
275	1.39	1.45	1.50	1.56	1.61	1.67	1.74	1.81	1.88	1.95	2.03	2.10	2.18
300	1.43	1.49	1.54	1.60	1.66	1.72	1.79	1.86	1.93	2.00	2.09	2.16	2.25
325	1.48	1.54	1.60	1.66	1.72	1.78	1.85	1.92	2.00	2.07	2.16	2.23	2.32
350	1.53	1.59	1.65	1.71	1.77	1.84	1.91	1.99	2.07	2.14	2.23	2.31	2.40

Note: Table 3 has inverted values.
Actual density ratio is the reciprocal of the above values.



Direct Drive, Type AV

Direct Drive, Type AV, with Internal Vanes



Series 65



Hartzell Fan, Inc. certifies that the Adjustable Pitch Vaneaxial Blowers, Series 65, shown on pages 10 through 19, are authorized to bear CE Marking in accordance with Machinery Safety Directive 98/37/EC of the European Union. Reference Technical File E.S. 13.2.1.

**ABS Certificate
of Design Assessment
Received**

Series 65 offers an external vane section. Foot mounted motors are standard to provide easy replacement.

Series 65C offers an internal vane section, which provides for a more compact installation package. "C" face, TEFC motors are standard. This product is AMCA Licensed for Air and Sound.

Performance: Capacity to 200,000 CFM; 35" to 79" wheel diameters (900 to 2000 millimeters); works to 6" static pressure; total efficiencies to 85%; 9-blade, cast aluminum assembly. Tip speeds to 22,000 FPM.

Standard configuration: direct drive.

Hub and Blades are cast from 319 aluminum alloy. Designed with ample safety factors, individually ground for balance. Electronically balanced at operational speed to ensure vibration-free, reliable service. Individual blades are balanced against a master; also balanced as complete assembly. Aluminum hub covers are standard.

Housings are heavy gauge hot-rolled steel with continuously welded steel drum and rolled steel flanges, continuously welded to drum. Provides rigid support, easy and accurate installation.

Heavy-duty **motor mounting plate** provides positive alignment and support. Blade tip clearance is consistently maintained.



Series 65C



Hartzell Fan, Inc. certifies that the Series 65C, Direct Drive, Adjustable Pitch Vaneaxial Fan, C-Faced Motor shown hereon, is licensed to bear the AMCA seal for air and sound. The ratings shown are based on tests and procedures performed in accordance with AMCA Publication 211 and AMCA Publication 311 and comply with the requirements of the AMCA Certified Ratings Program.

Sound performance data is available upon request. Please contact the factory and ask for Engineering Publication #SD-142.

Straightening Vanes: Heavy gauge steel discharge guide vanes are welded in the casing. Aerodynamically designed straightening vanes maximize efficiency. Vanes minimize turbulence, converting velocity pressure to static pressure for increased capability.

Standard **surface coating** is an industrial grade alkyd enamel. Surfaces are cleaned, phosphatized and dried prior to application. Coating is suitable for inside or outside industrial structures.

Extended **lube tubes** from motor to exterior of fan housing are standard.

Extended **motor leads** to exterior of housing are available as an option on Series 65. Extended leads are standard on Series 65C.

Accessories: see pages 26-27.

Temperature: see page 27 for temperature limitations.



Dimensions

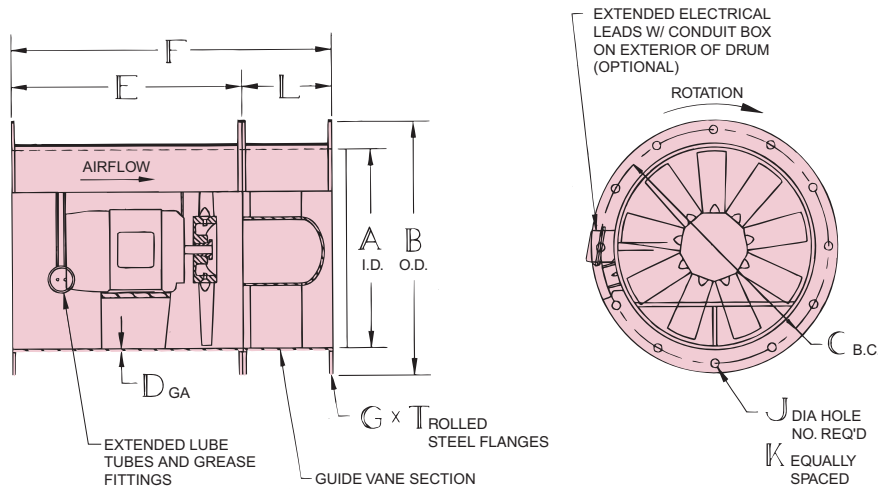

Principal Dimensions (Series 65, Direct Drive)

FAN SIZE	A	B	C	D	E	F	G	J	K	L	T	MAX MTR FRAME
35	35½	39⅞	38	7	34	46 ¹¹ / ₁₆	2	⅞	12	12 ¹¹ / ₁₆	¼	326T
39	39⅞	43⅞	41⅞	¼	38	51¾	2	⅞	12	13¾	⅜	365T
44	44⅞	49⅞	47⅞	¼	42	56	2½	⅞	12	14	⅜	405T
49	49¾	54¾	52½	¼	48	62 ¹³ / ₁₆	2½	⅞	12	14 ¹³ / ₁₆	⅜	445T
57	57⅞	62⅞	60⅞	¼	48	66¾	2½	⅞	12	18¾	⅜	445T
63	63	68½	66¼	¼	48	68	2½	¹¹ / ₁₆	16	20	⅜	445T
71	70⅞	77⅞	75	⅜	56	77⅞	3 x 3	¹¹ / ₁₆	16	21 ⁵ / ₈	⅜	449TY
79	78¾	85½	82⅞	⅜	56	78⅞	3 x 3	¹¹ / ₁₆	16	22⅞	⅜	449TY

Dimensions and specifications subject to change. Certified prints are available.

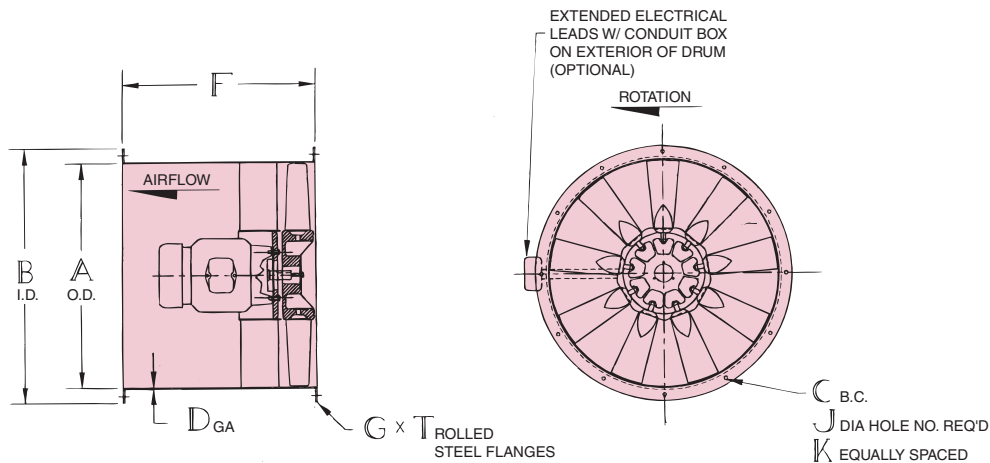

Principal Dimensions (Series 65C, Direct Drive)

FAN SIZE	SIZE (MM)	A	B	C	D	F	G	J	K	T	MINIMUM MOTOR FRAME	MAXIMUM MOTOR FRAME (ODP)	MAXIMUM MOTOR FRAME (TEFC)
35	900	35½	39⅞	38	7	30	2	⅞	12	¼	182TC	286TC	256TC
39	1000	39⅞	43⅞	41⅞	7	30	2	⅞	12	⅜	182TC	286TC	256TC
44	1120	44⅞	49⅞	47⅞	7	34	2½	⅞	12	⅜	213TC	326TC	286TC
49	1250	49¾	54¾	52½	7	34	2½	⅞	12	⅜	213TC	326TC	286TC
57	1450	57⅞	62⅞	60⅞	¼	42	2½	⅞	12	⅜	254TC	405TC	405TC
63	1600	63	68½	66¼	¼	42	2½	¹¹ / ₁₆	16	⅜	254TC	405TC	405TC
71	1800	70⅞	77⅞	75	¼	54	3 x 3	¹¹ / ₁₆	16	½	324TC	449TC	449TC
79	2000	78¾	85½	82⅞	¼	54	3 x 3	¹¹ / ₁₆	16	½	324TC	449TC	449TC

Dimensions and specifications subject to change. Certified prints are available.



Hartzell Performance Curves Series 65

65---359AV__STAO_5, 870 RPM, 0.075 #/Cu. Ft.

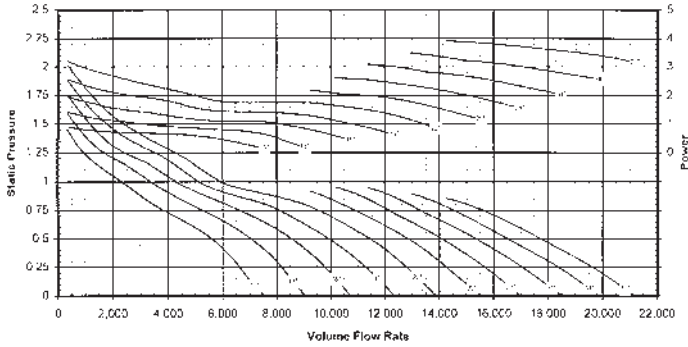

65---359AV__STAO_4, 1160 RPM, 0.075 #/Cu. Ft.

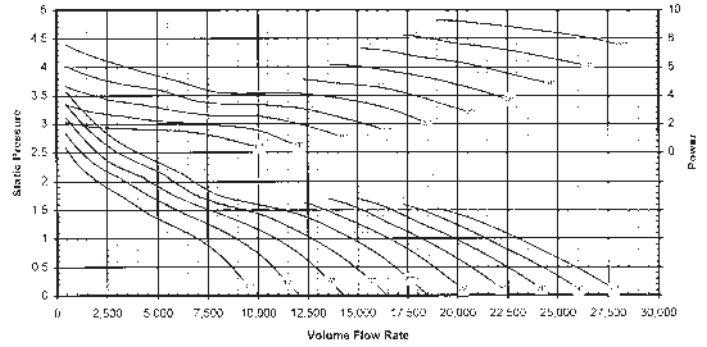

65---359AV__STAO_3, 1750 RPM, 0.075 #/Cu. Ft.

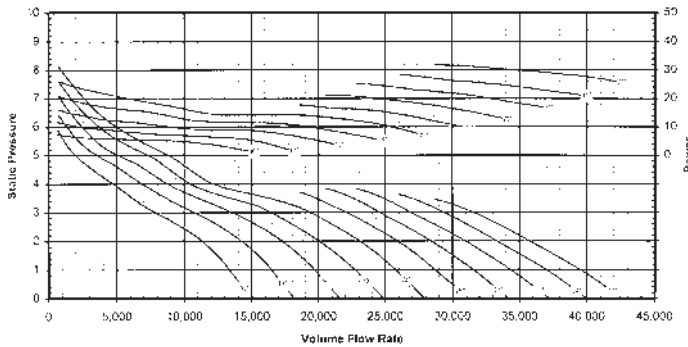

65---399AV__STAO_6, 690 RPM, 0.075 #/Cu. Ft.

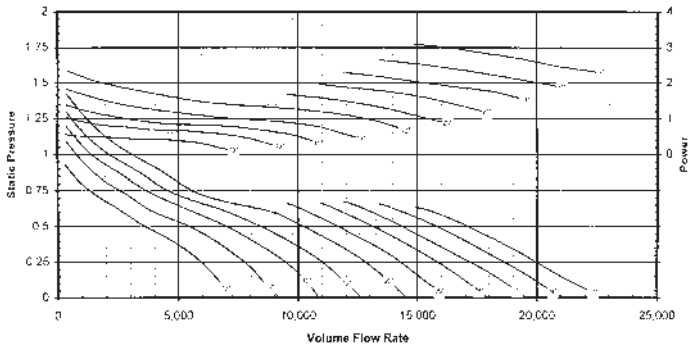

65---399AV__STAO_5, 870 RPM, 0.075 #/Cu. Ft.

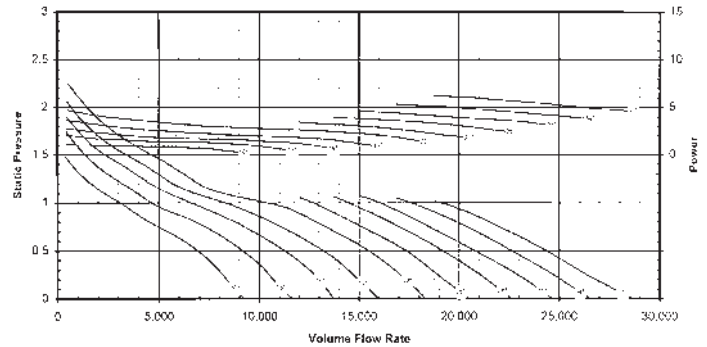

65---399AV__STAO_4, 1160 RPM, 0.075 #/Cu. Ft.

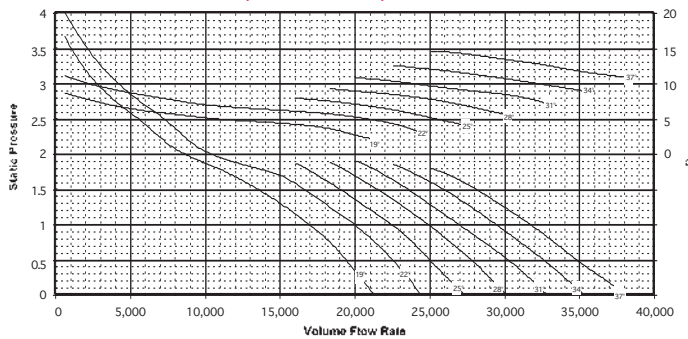

Performance is for installation type D – Ducted inlet, Ducted outlet. Performance ratings do not include the affects of appurtenances (accessories). Air and Sound Performance Data is available in Hartzell ESP (Electronic Support Package). Please visit www.hartzellfan.com to request a copy.

To complete the model code for your selection, add the designation for the blade angle and motor name plate HP in the appropriate space. See page 2 for the complete Hartzell Model Code Explanation and example.



65---399AV__STAO_3, 1750 RPM, 0.075 #/Cu. Ft.

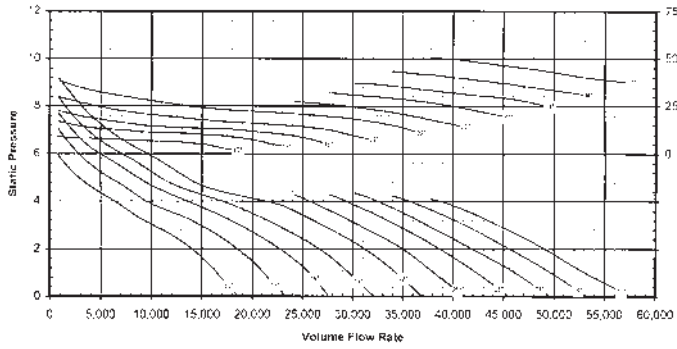

65---449AV__STAO_6, 690 RPM, 0.075 #/Cu. Ft.

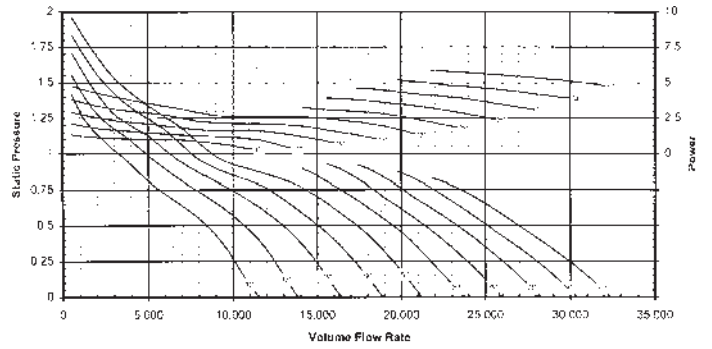

65---449AV__STAO_5, 870 RPM, 0.075 #/Cu. Ft.

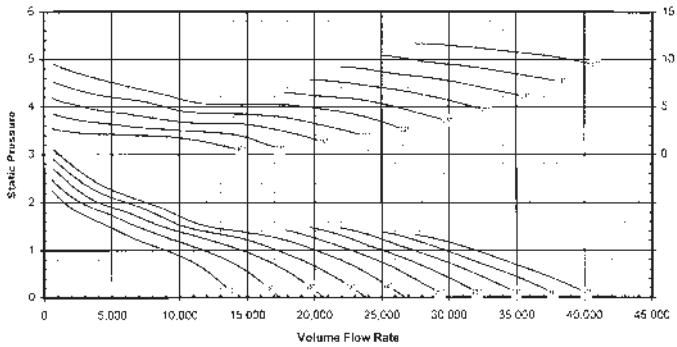

65---449AV__STAO_4, 1160 RPM, 0.075 #/Cu. Ft.

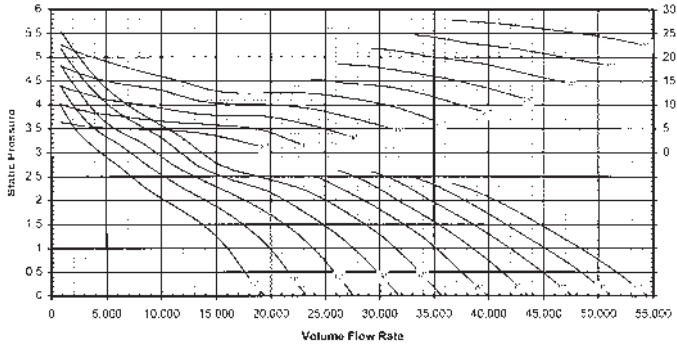

65---449AV__STAO_3, 1750 RPM, 0.075 #/Cu. Ft.

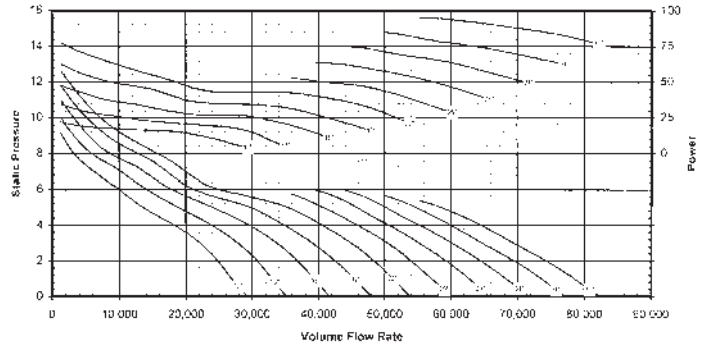

65---499AV__STAO_6, 690 RPM, 0.075 #/Cu. Ft.

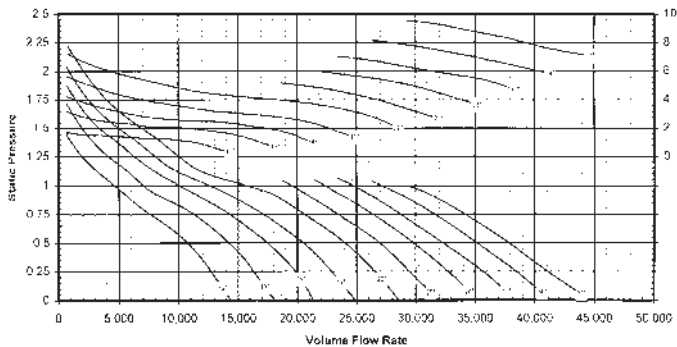

Performance is for installation type D – Ducted inlet, Ducted outlet. Performance ratings do not include the affects of appurtenances (accessories). Air and Sound Performance Data is available in Hartzell ESP (Electronic Support Package). Please visit www.hartzellfan.com to request a copy.

To complete the model code for your selection, add the designation for the blade angle and motor name plate HP in the appropriate space. See page 2 for the complete Hartzell Model Code Explanation and example.



65---499AV__STAO_5, 870 RPM, 0.075 #/Cu. Ft.

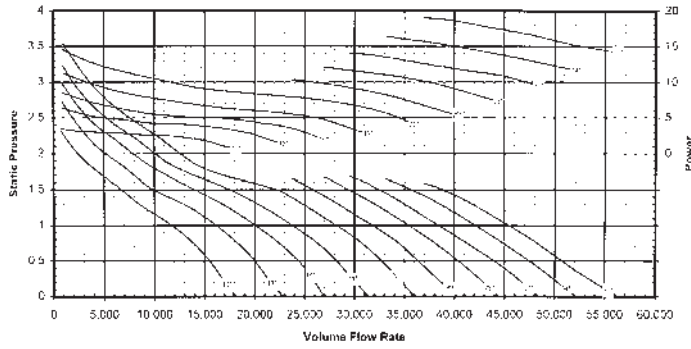

65---499AV__STAO_4, 1160 RPM, 0.075 #/Cu. Ft.

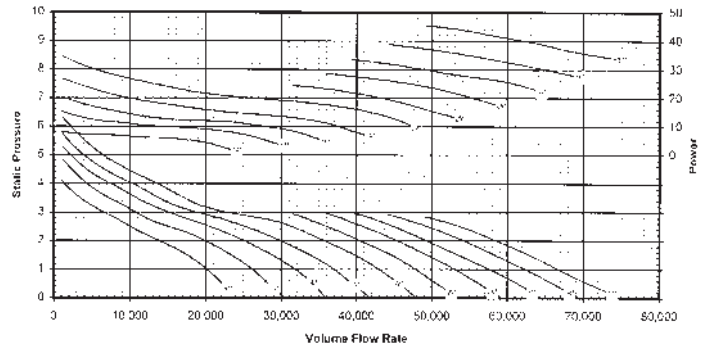

65---499AV__STAO_3, 1750 RPM, 0.075 #/Cu. Ft.

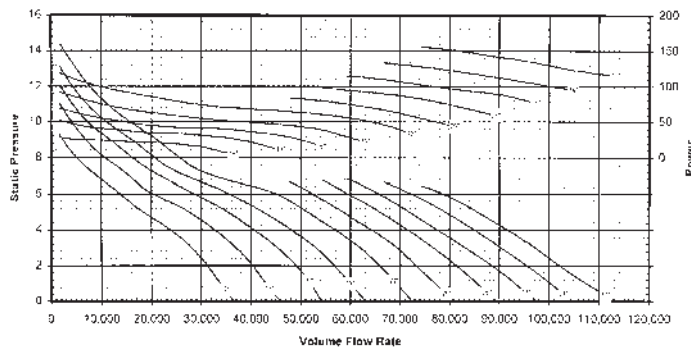

65---579AV__STAO_6, 690 RPM, 0.075 #/Cu. Ft.

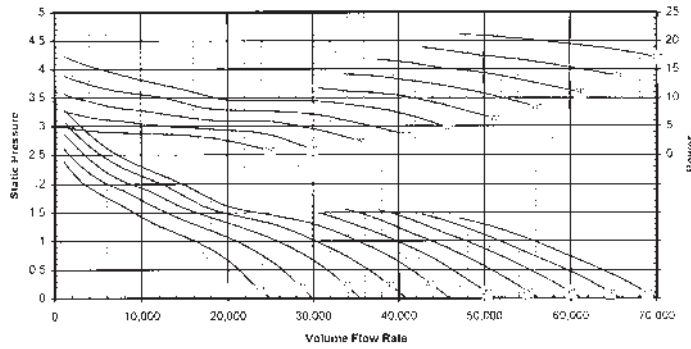

65---579AV__STAO_5, 870 RPM, 0.075 #/Cu. Ft.

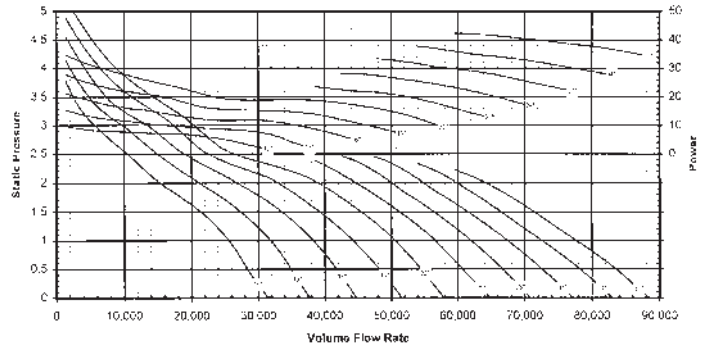

65---579AV__STAO_4, 1160 RPM, 0.075 #/Cu. Ft.

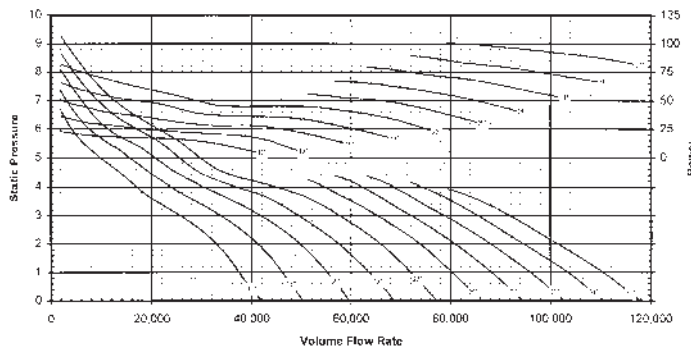

Performance is for installation type D – Ducted inlet, Ducted outlet. Performance ratings do not include the affects of appurtenances (accessories). Air and Sound Performance Data is available in Hartzell ESP (Electronic Support Package). Please visit www.hartzellfan.com to request a copy.

To complete the model code for your selection, add the designation for the blade angle and motor name plate HP in the appropriate space. See page 2 for the complete Hartzell Model Code Explanation and example.



65---639AV__STAO_6, 690 RPM, 0.075 #/Cu. Ft.

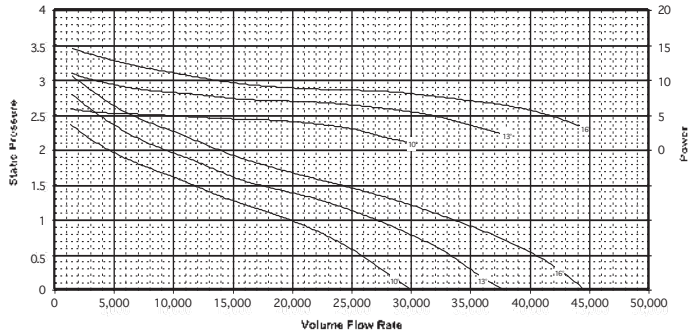

65---639AV__STAO_5, 870 RPM, 0.075 #/Cu. Ft.

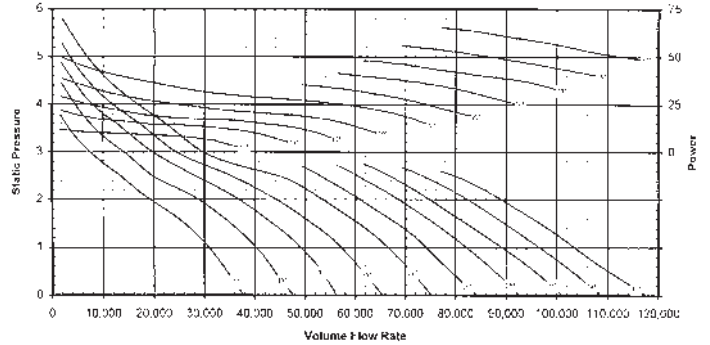

65---639AV__STAO_4, 1160 RPM, 0.075 #/Cu. Ft.

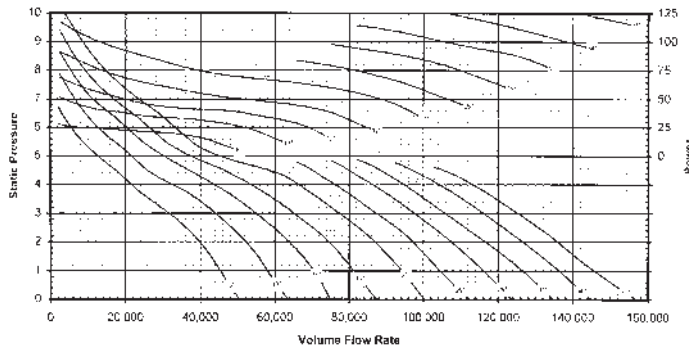

65---719AV__STAO_6, 690 RPM, 0.075 #/Cu. Ft.

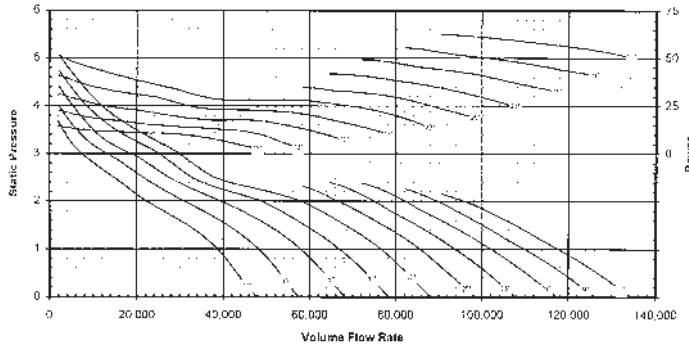

65---719AV__STAO_5, 870 RPM, 0.075 #/Cu. Ft.

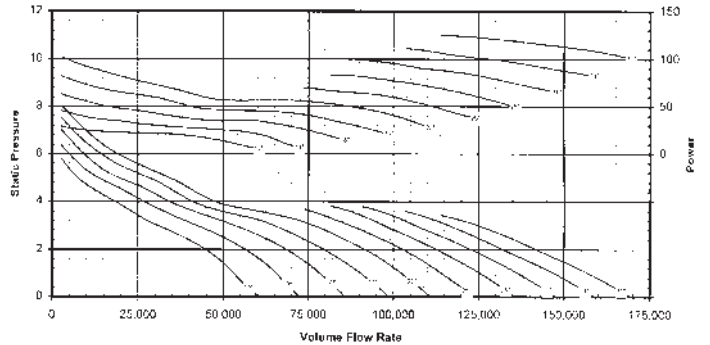

65---719AV__STAO_4, 1160 RPM, 0.075 #/Cu. Ft.

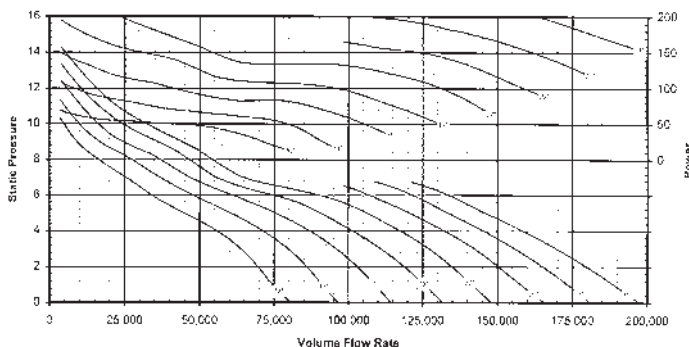

Performance is for installation type D – Ducted inlet, Ducted outlet. Performance ratings do not include the affects of appurtenances (accessories). Air and Sound Performance Data is available in Hartzell ESP (Electronic Support Package). Please visit www.hartzellfan.com to request a copy.

To complete the model code for your selection, add the designation for the blade angle and motor name plate HP in the appropriate space. See page 2 for the complete Hartzell Model Code Explanation and example.



65---799AV_STAO_6, 690 RPM, 0.075 #/Cu. Ft.

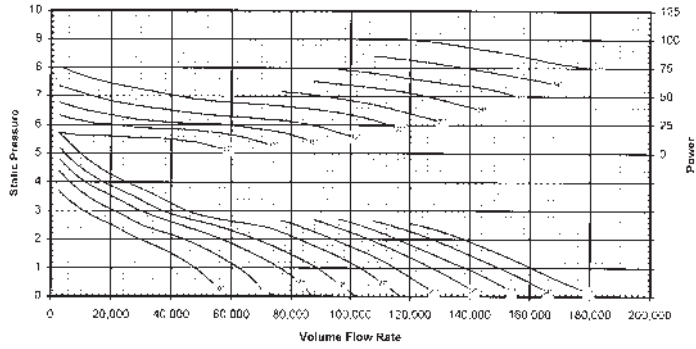

65---799AV_STAO_5, 870 RPM, 0.075 #/Cu. Ft.

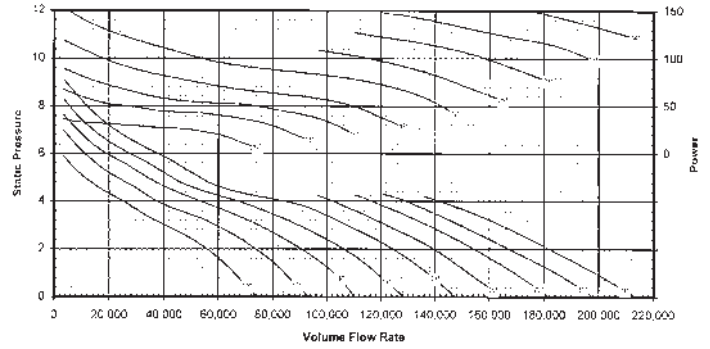

65---799AV_STAO_4, 1160 RPM, 0.075 #/Cu. Ft.

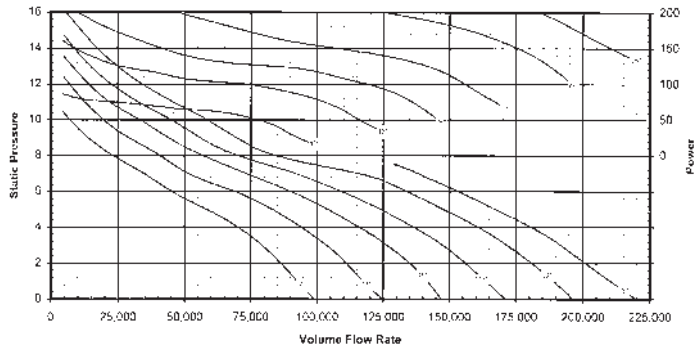

Performance is for installation type D – Ducted inlet, Ducted outlet. Performance ratings do not include the affects of appurtenances (accessories). Air and Sound Performance Data is available in Hartzell ESP (Electronic Support Package). Please visit www.hartzellfan.com to request a copy.

To complete the model code for your selection, add the designation for the blade angle and motor name plate HP in the appropriate space. See page 2 for the complete Hartzell Model Code Explanation and example.



Hartzell Performance Curves Series 65C

65C--359AV__STCF_5, 870 RPM, 0.075 #/Cu. Ft.

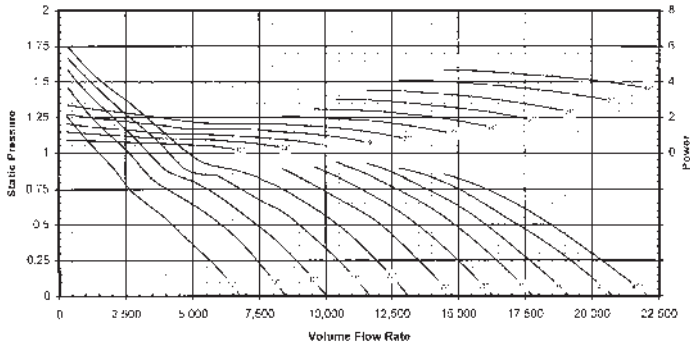

65C--359AV__STCF_4, 1160 RPM, 0.075 #/Cu. Ft.

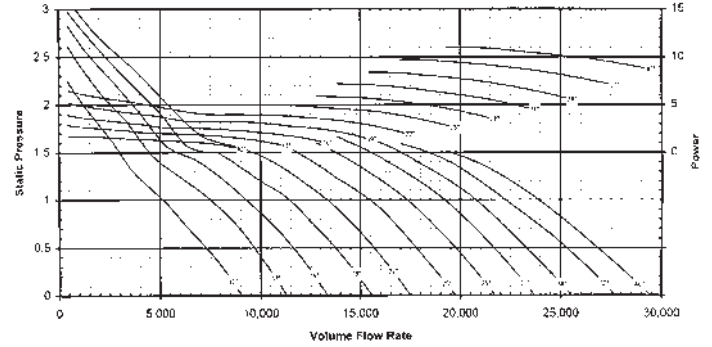

65C--359AV__STCF_3, 1750 RPM, 0.075 #/Cu. Ft.

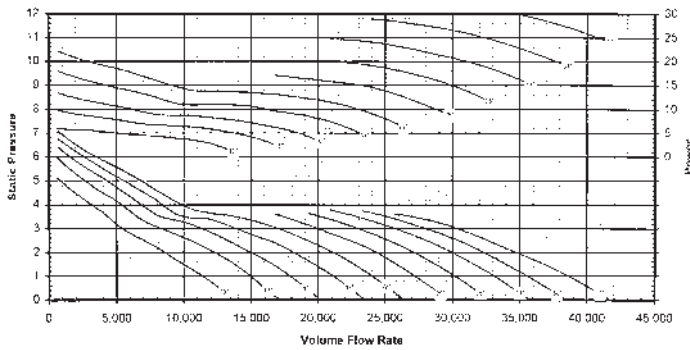

65C--399AV__STCF_6, 690 RPM, 0.075 #/Cu. Ft.

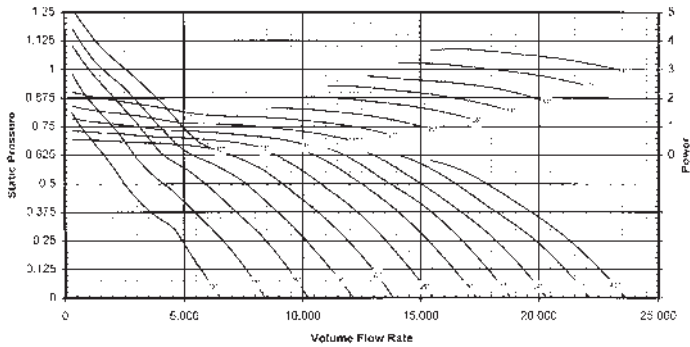

65C--399AV__STCF_5, 870 RPM, 0.075 #/Cu. Ft.

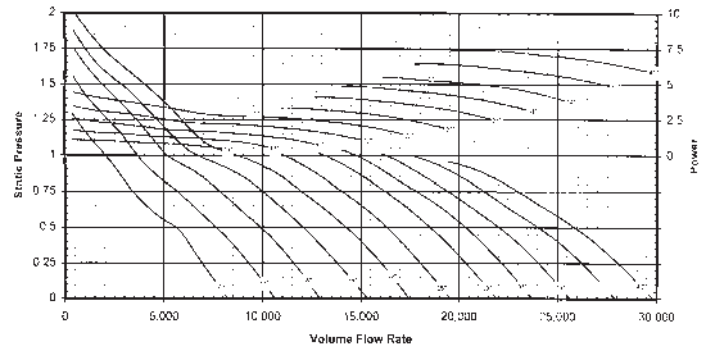

65C--399AV__STCF_4, 1160 RPM, 0.075 #/Cu. Ft.

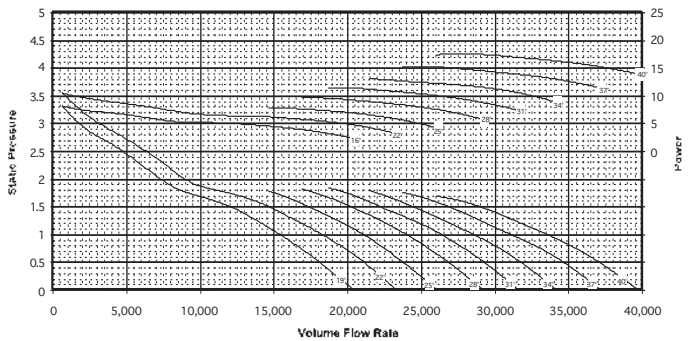

Performance is for installation type D – Ducted inlet, Ducted outlet. Performance ratings do not include the affects of appurtenances (accessories). Air and Sound Performance Data is available in Hartzell ESP (Electronic Support Package). Please visit www.hartzellfan.com to request a copy.

To complete the model code for your selection, add the designation for the blade angle and motor name plate HP in the appropriate space. See page 2 for the complete Hartzell Model Code Explanation and example.



65C--399AV_STCF_3, 1750 RPM, 0.075 #/Cu. Ft.

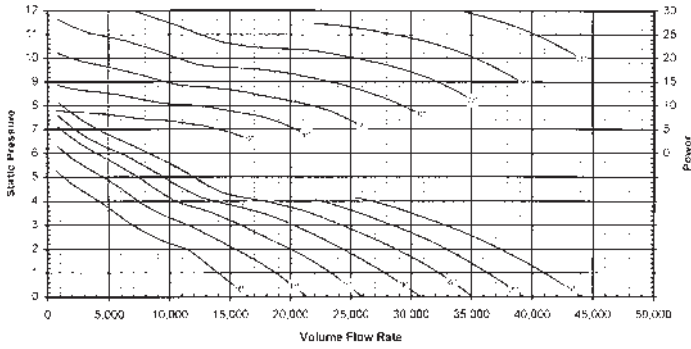

65C--449AV_STCF_6, 690 RPM, 0.075 #/Cu. Ft.

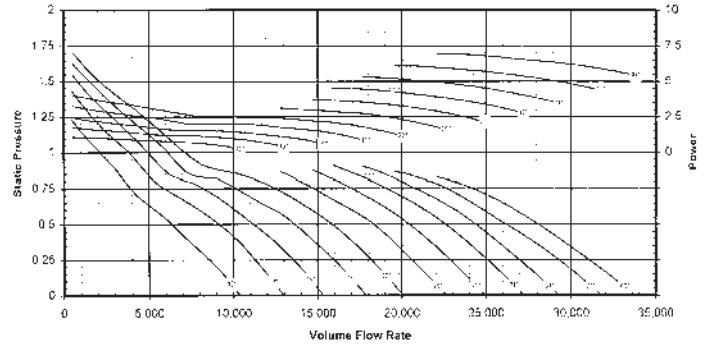

65C--449AV_STCF_5, 870 RPM, 0.075 #/Cu. Ft.

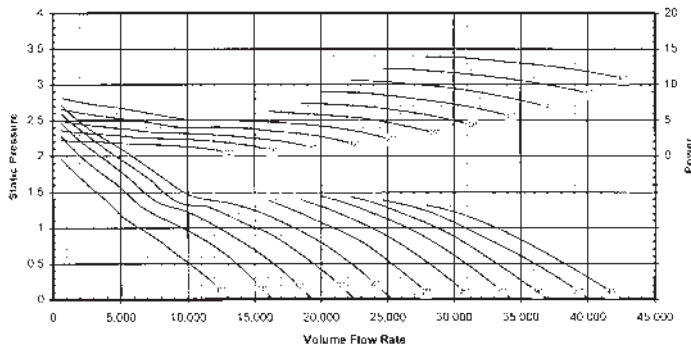

65C--449AV_STCF_4, 1160 RPM, 0.075 #/Cu. Ft.

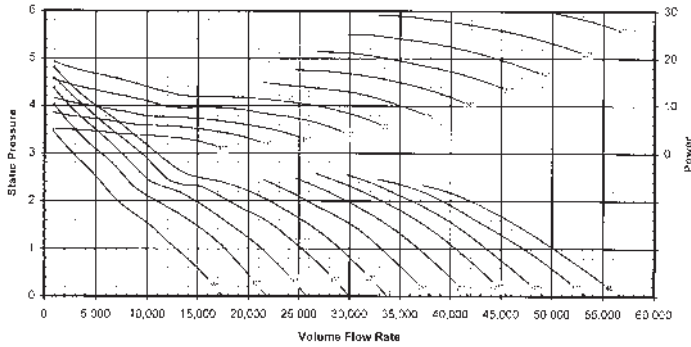

65C--449AV_STCF_3, 1750 RPM, 0.075 #/Cu. Ft.

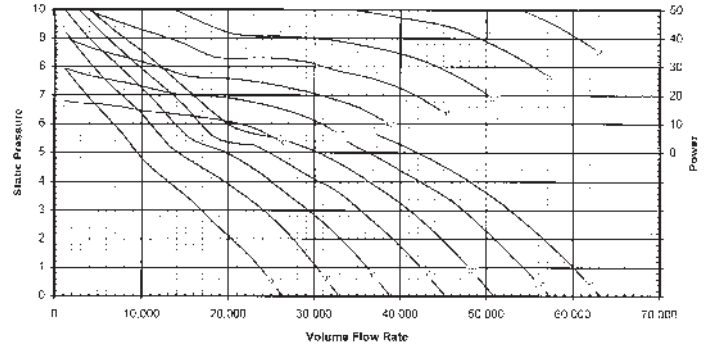

65C--499AV_STCF_6, 690 RPM, 0.075 #/Cu. Ft.

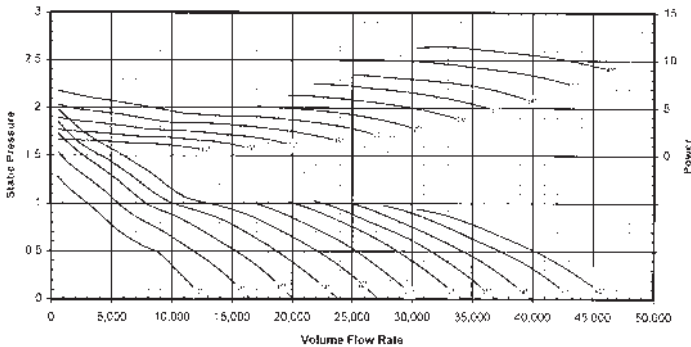

Performance is for installation type D – Ducted inlet, Ducted outlet. Performance ratings do not include the affects of appurtenances (accessories). Air and Sound Performance Data is available in Hartzell ESP (Electronic Support Package). Please visit www.hartzellfan.com to request a copy.

To complete the model code for your selection, add the designation for the blade angle and motor name plate HP in the appropriate space. See page 2 for the complete Hartzell Model Code Explanation and example.



65C--499AV__STCF_5, 870 RPM, 0.075 #/Cu. Ft.

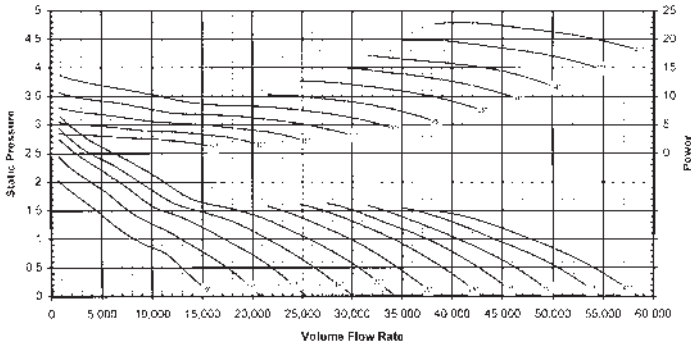

65C--499AV__STCF_4, 1160 RPM, 0.075 #/Cu. Ft.

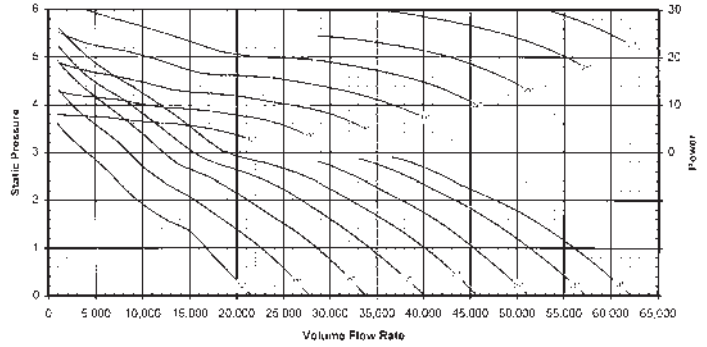

65C--499AV__STCF_3, 1750 RPM, 0.075 #/Cu. Ft.

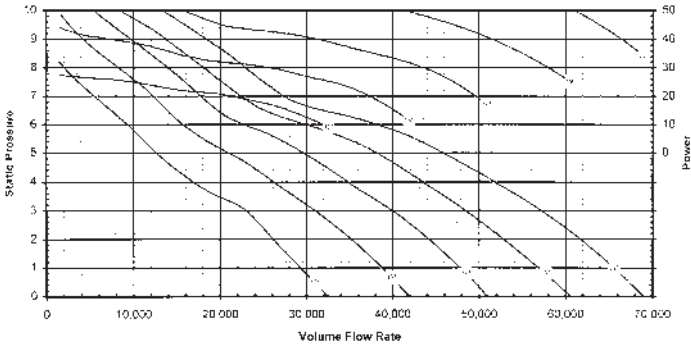

65C--579AV__STCF_6, 690 RPM, 0.075 #/Cu. Ft.

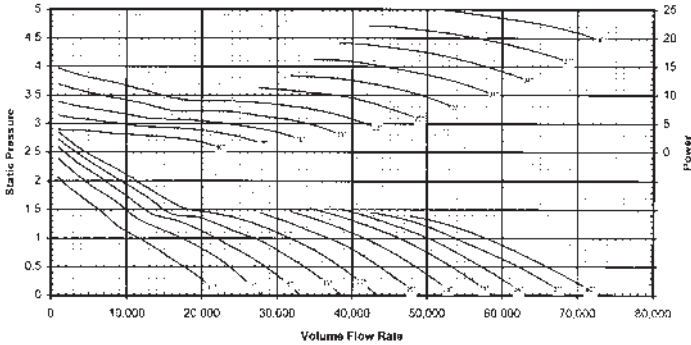

65C--579AV__STCF_5, 870 RPM, 0.075 #/Cu. Ft.

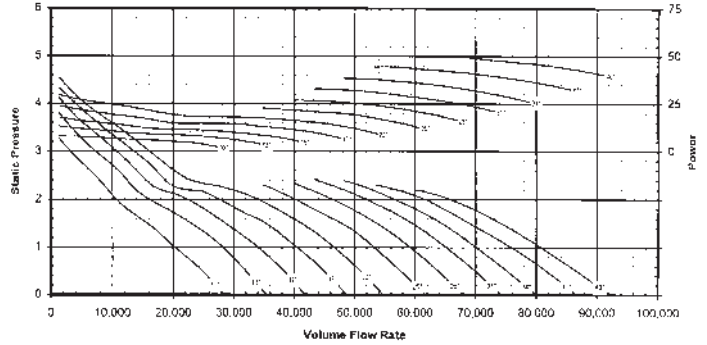

65C--579AV__STCF_4, 1160 RPM, 0.075 #/Cu. Ft.

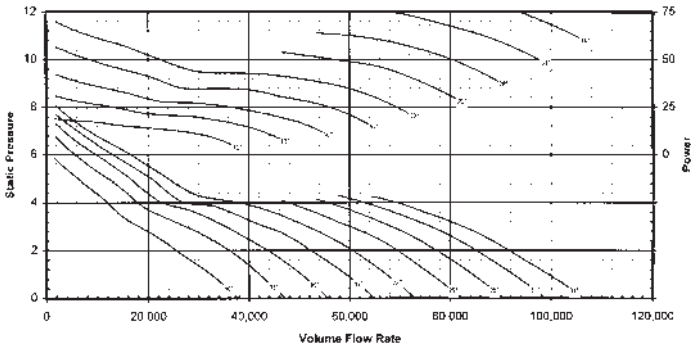

Performance is for installation type D – Ducted inlet, Ducted outlet. Performance ratings do not include the affects of appurtenances (accessories). Air and Sound Performance Data is available in Hartzell ESP (Electronic Support Package). Please visit www.hartzellfan.com to request a copy.

To complete the model code for your selection, add the designation for the blade angle and motor name plate HP in the appropriate space. See page 2 for the complete Hartzell Model Code Explanation and example.



65C--639AV__STCF_6, 690 RPM, 0.075 #/Cu. Ft.

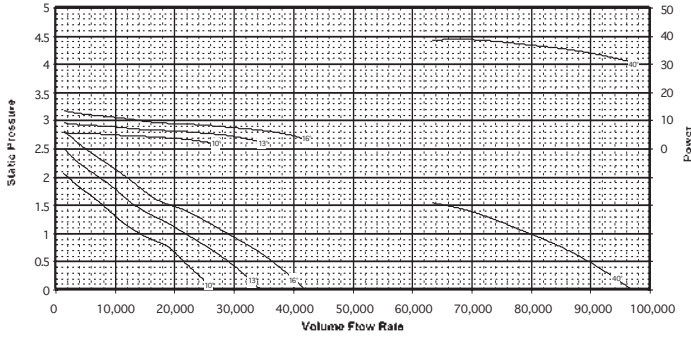

65C--639AV__STCF_5, 870 RPM, 0.075 #/Cu. Ft.

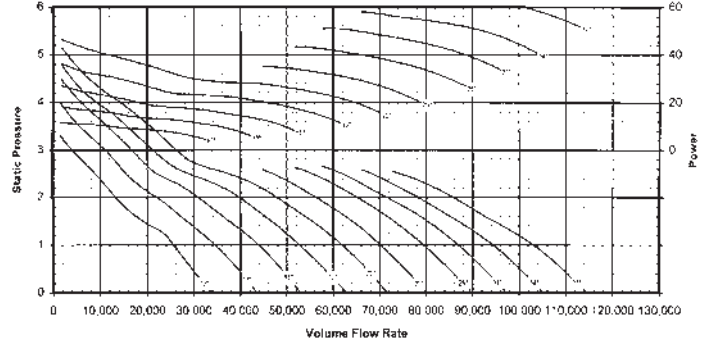

65C--639AV__STCF_4, 1160 RPM, 0.075 #/Cu. Ft.

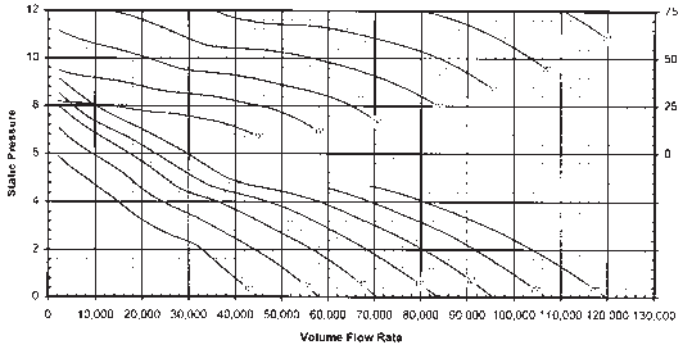

65C--719AV__STCF_6, 690 RPM, 0.075 #/Cu. Ft.

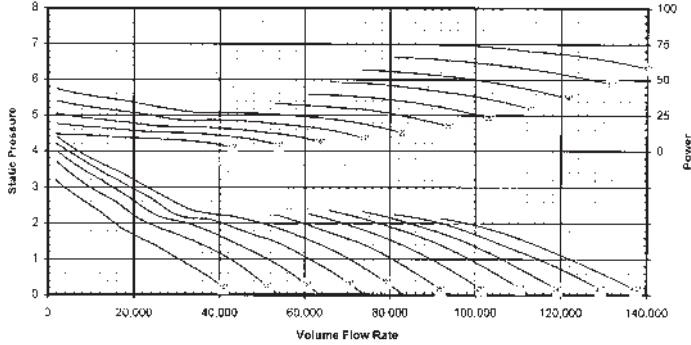

65C--719AV__STCF_5, 870 RPM, 0.075 #/Cu. Ft.

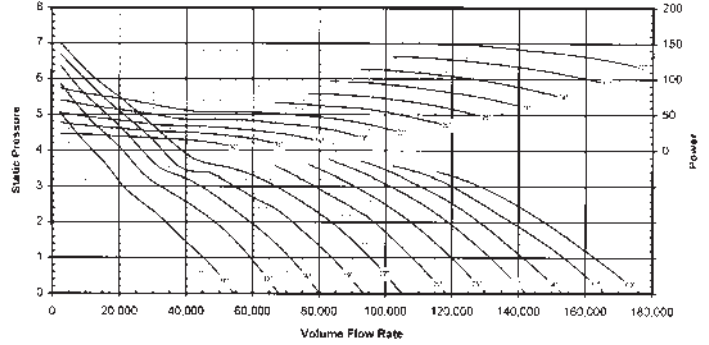

65C--719AV__STCF_4, 1160 RPM, 0.075 #/Cu. Ft.

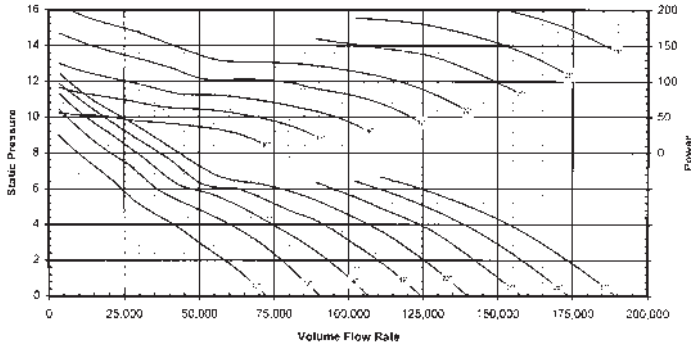

Performance is for installation type D – Ducted inlet, Ducted outlet. Performance ratings do not include the affects of appurtenances (accessories). Air and Sound Performance Data is available in Hartzell ESP (Electronic Support Package). Please visit www.hartzellfan.com to request a copy.

To complete the model code for your selection, add the designation for the blade angle and motor name plate HP in the appropriate space. See page 2 for the complete Hartzell Model Code Explanation and example.



65C--799AV__STCF_6, 690 RPM, 0.075 #/Cu. Ft.

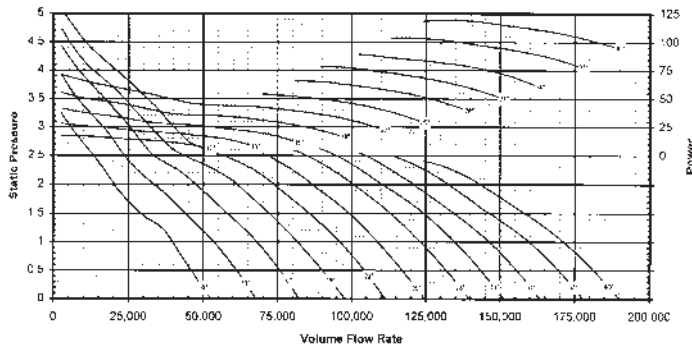

65C--799AV__STCF_5, 870 RPM, 0.075 #/Cu. Ft.

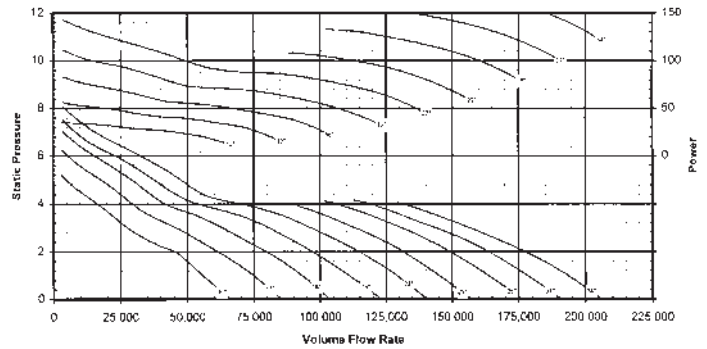

65C--799AV__STCF_4, 1160 RPM, 0.075 #/Cu. Ft.

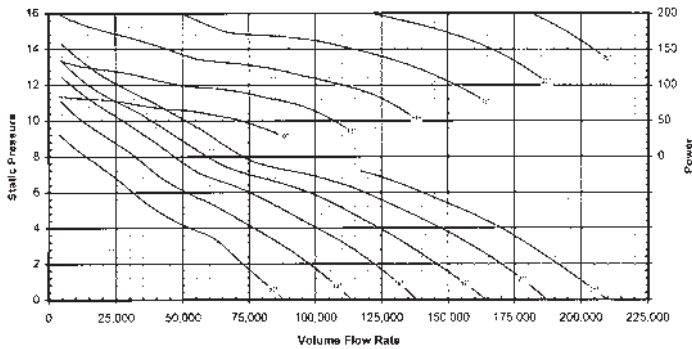

Performance is for installation type D – Ducted inlet, Ducted outlet. Performance ratings do not include the affects of appurtenances (accessories). Air and Sound Performance Data is available in Hartzell ESP (Electronic Support Package). Please visit www.hartzellfan.com to request a copy.

To complete the model code for your selection, add the designation for the blade angle and motor name plate HP in the appropriate space. See page 2 for the complete Hartzell Model Code Explanation and example.



Belt Drive, Type AV with Internal Vanes



Series 66

Series 66 is for installations where it is advantageous to have the motor out of the airstream or the versatility of a belt drive configuration. This fan can handle relatively clean and corrosive-free air. In installations where air is at elevated temperatures or is contaminated, Hartzell Series 67 should be used. See page 21.

Available in **sizes** 35" to 79" . . . with **performance** from 4000 CFM at 1" to 180,000 CFM at 2" SP with pressure capabilities up to 8". See pages 22-25.

Hub and Blades are cast from 319 aluminum alloy. Designed with ample safety factors, individually ground for balance. Electronically balanced at operational speed to ensure vibration-free, reliable service. Individual blades are balanced against a master; also balanced as complete assembly. Aluminum hub covers are standard.

Housing: One-piece, heavy gauge hot rolled steel housing with continuously welded steel drum and rolled steel flanges.

Internal Guide Vanes: Eleven heavy gauge steel discharge guide vanes are welded in the blower housing.

Bearings are heavy duty ball or roller type, in cast iron pillow block housings, selected for minimum L-50 Life of 500,000 hours for horizontal fans; and 250,000 for vertical fans, and include extended lubrication fittings as standard. Shafts are turned ground and polished 1045 steel sized to operate well below critical speed.

Motor out of the air stream: Exterior mounting. Propeller shaft rotates in two heavy duty bearings mounted on steel supports welded to the inner shell with "T" reinforcements. Open end motors are standard. Motors larger than 30 HP will be shipped separately for mounting on unit at job site.

Drives are fixed pitch as standard. Variable pitch drives are available upon request.

Extended lube tubes from bearings to exterior of fan housing are standard.

High Temperature Construction: Maximum temperature of 180°F. For temperatures above 180°F, see page 21.

Accessories: See pages 26-27.



Hartzell Fan, Inc. certifies that the Series 66, Belt Drive, Adjustable Pitch Vaneaxial Fan, Type AV, with Internal Vanes shown hereon, is licensed to bear the AMCA seal for air and sound. The ratings shown are based on tests and procedures performed in accordance with AMCA Publication 211 and AMCA Publication 311 and comply with the requirements of the AMCA Certified Ratings Program.

Sound performance data is available upon request. Please contact the factory and ask for Engineering Publication #SD-142.

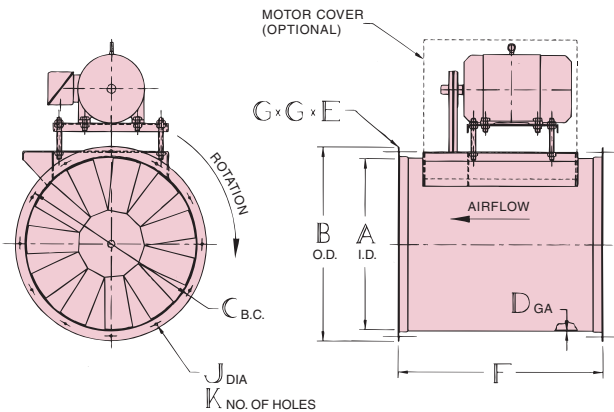

Principal Dimensions (Series 66, Belt Drive)

FAN SIZE	SIZE (MM)	A	B	C	D	E	F	G	J	K
35	900	35½	39⅝	38	⅜	¼	43	2	⅝	12
39	1000	39⅝	43⅝	41⅝	¼	⅜	43	2	⅝	12
44	1120	44⅝	49⅝	47⅝	¼	⅜	47	2½	⅝	12
49	1250	49¾	54¾	52½	¼	⅜	47	2½	⅝	12
57	1450	57⅝	62⅝	60⅝	¼	⅜	61	2½	⅝	12
63	1600	63	68⅝	66¾	¼	⅜	61	2½	1⅜	16
71	1800	70⅝	77⅝	75	⅜	½	72	3	1⅜	16
79	2000	78¾	85⅝	82⅝	⅜	½	72	3	1⅜	16

Dimensions and specifications subject to change. Certified prints are available.



Belt Drive, Type AV



Series 67

**ABS Certificate
of Design Assessment
Received**

Series 67 is for installations where air is hot or contaminated. The Series 67 high temperature Adjustable Pitch Vaneaxial will provide substantially longer service life than standard belt drive vaneaxial blowers.

Available in **sizes** 35" to 79" . . . with **performance** from 4000 CFM at 1" to 180,000 CFM at 2" SP with pressure capabilities up to 8". See pages 22-25.

Hub and Blades are cast from 319 aluminum alloy. Designed with ample safety factors, individually ground for balance. Electronically balanced at operational speed to ensure vibration-free, reliable service. Individual blades are balanced against a master; also balanced as complete assembly. Aluminum hub covers are standard.

High Temperature Construction: Belts, bearings, sheave and shaft are enclosed and protected from the air stream. Special guide vane section on discharge side allows for location of drive compartment on the negative-pressure (suction) side of the propeller, drawing ambient air from outside the blower in and over the belts and bearings. Allows use in temperatures up to 350°F if the ambient temperature does not exceed the motor rating.

Housings: Two-piece, heavy gauge hot rolled steel housing with continuously welded steel drum and rolled steel flanges.

Vane Section: Separate vane section containing guide vanes is located on the discharge side of the blower.

Bearings are heavy duty ball or roller type, in cast iron pillow block housings, selected for minimum L-50 Life of 500,000 hours for horizontal fans; and 250,000 for vertical fans, and include extended lubrication fittings as standard. Shafts are turned ground and polished 1045 steel sized to operate well below critical speed.

Motor out of the air stream: Exterior mounting. Propeller shaft rotates in two heavy duty bearings mounted on steel supports welded to the inner shell with "T" reinforcements. Open end motors are standard. Motors larger than 30HP will be shipped separately for mounting on unit at job site.

Drives: are fixed pitch as standard. Variable pitch drives are available upon request.

Extended lube tubes from bearings to exterior of fan housing are standard.

Accessories: See pages 26-27.

Protective coatings: see page 26.

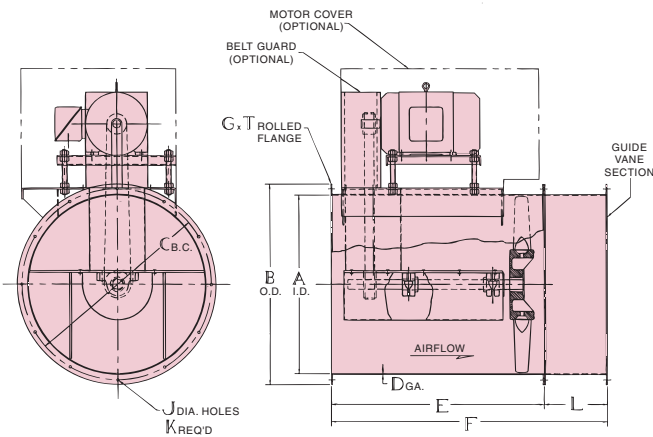

Principal Dimensions (Series 67, Belt Drive)

FAN SIZE	A	B	C	D	E	F	G	J	K	L	T	EST WT.	
												FAN SECTION	VANE SECTION
35	35½	39½	38	7 GA.	43	55 ¹¹ / ₁₆	2	⁹ / ₁₆	12	12 ¹¹ / ₁₆	¹ / ₄	640	150
39	39¾	43¾	41¾	¹ / ₄	43	56¾	2	⁹ / ₁₆	12	13¾	³ / ₈	830	235
44	44¾	49¾	47¾	¹ / ₄	47	61	2½	⁹ / ₁₆	12	14	³ / ₈	995	285
49	49¾	54¾	52½	¹ / ₄	47	61 ¹³ / ₁₆	2½	⁹ / ₁₆	12	14 ¹³ / ₁₆	³ / ₈	1370	395
57	57½	62½	60¾	¹ / ₄	61	79¾	2½	⁹ / ₁₆	12	18¾	³ / ₈	1800	455
63	63	68½	66¼	¹ / ₄	61	81	2½	¹¹ / ₁₆	16	20	³ / ₈	2045	530
71	70¾	77¾	75	³ / ₈	72	93¾	3	¹¹ / ₁₆	16	21¾	¹ / ₂	3300	1020
79	78¾	85½	82¾	³ / ₈	72	94¾	3	¹¹ / ₁₆	16	22¾	¹ / ₂	3630	1200

Dimensions and specifications subject to change. Certified prints are available.



Performance Data, Series 66 & 67

66---359AV_STOP_3 or 67---359AV_STOP_3

CFM	Outlet Velocity F/M	Static Pressure																							
		1.0'			2.0'			3.0'			4.0'			5.0'			6.0'			7.0'			8.0'		
		RPM	Bld. °	BHP	RPM	Bld. °	BHP	RPM	Bld. °	BHP	RPM	Bld. °	BHP	RPM	Bld. °	BHP	RPM	Bld. °	BHP	RPM	Bld. °	BHP	RPM	Bld. °	BHP
8,592	1,250	1,101	16°	2.70	1,501	13°	5.69	1,743	13°	9.15	1,946	13°	12.96	2,121	13°	17.02	2,272	13°	21.27	2,283	16°	28.38	2,282	19°	36.71
10,310	1,500	1,015	22°	3.21	1,459	16°	6.54	1,827	13°	10.30	2,031	13°	14.43	2,211	13°	18.86	2,372	13°	23.53	2,266	19°	33.62	2,380	19°	39.71
12,029	1,750	1,087	22°	3.80	1,550	16°	7.55	1,762	16°	11.60	2,116	13°	15.98	2,295	13°	20.71	2,323	16°	27.39	2,366	19°	36.56	2,374	22°	46.61
13,747	2,000	1,164	22°	4.53	1,404	22°	8.60	1,844	16°	12.95	2,029	16°	17.74	2,381	13°	22.89	2,377	16°	29.08	2,340	22°	42.38			
15,466	2,250	1,153	25°	5.37	1,471	22°	9.64	1,782	19°	14.60	2,108	16°	19.47	2,272	16°	24.90	2,319	19°	32.90						
17,184	2,500	1,231	25°	6.34	1,544	22°	10.88	1,732	22°	16.09	2,202	16°	21.59	2,351	16°	27.06	2,353	19°	34.37						
18,902	2,750	1,157	31°	7.41	1,621	22°	12.32	1,800	22°	17.67	2,108	19°	23.87	2,252	19°	29.78	2,314	22°	36.72						
20,621	3,000	1,221	31°	8.59	1,577	25°	13.94	1,873	22°	19.50	2,030	22°	25.68	2,332	19°	32.49	2,342	22°	40.37						
22,339	3,250	1,288	31°	9.93	1,651	25°	15.67	1,948	22°	21.57	2,100	22°	27.90	2,242	22°	34.84	2,381	22°	42.44						
24,058	3,500	1,357	31°	11.44	1,729	25°	17.64	2,027	22°	23.89	2,173	22°	30.39	2,309	22°	37.46									
25,776	3,750	1,428	31°	13.15	1,800	31°	19.78	1,953	25°	26.36	2,248	22°	33.17	2,382	22°	40.40	2,366	25°	50.26						
27,494	4,000	1,500	31°	15.06	1,664	31°	21.86	2,026	25°	29.01	2,327	22°	36.24	2,292	25°	44.52									
29,213	4,250	1,575	31°	17.19	1,729	31°	24.35	2,106	25°	31.95	2,232	25°	39.53	2,357	25°	47.77	2,359	28°	58.42						
30,931	4,500	1,651	31°	19.55	1,795	31°	27.00	1,935	31°	35.19	2,306	25°	42.94	2,304	28°	52.77	2,294	31°	63.19						
32,650	4,750	1,728	31°	22.15	1,863	31°	29.88	2,127	28°	38.67	2,382	25°	46.66	2,366	28°	56.51	2,349	31°	67.11						
34,368	5,000	1,805	31°	25.00	1,933	31°	33.01	2,064	31°	41.76	2,185	31°	51.08	2,298	31°	60.95									
36,086	5,250	1,883	31°	28.13	1,915	34°	37.75	2,129	31°	45.44	2,249	31°	55.05	2,358	31°	65.16									
37,805	5,500	1,962	31°	31.53	2,076	31°	40.12	2,196	31°	49.41	2,313	31°	59.32	2,335	34°	73.72									
39,523	5,750	1,928	34°	35.91	2,150	31°	44.12	2,264	31°	53.68	2,377	31°	63.85												
41,242	6,000	2,121	31°	39.24	2,225	31°	48.43	2,333	31°	58.26	2,346	34°	71.88												

66---399AV_STOP_3 or 67---399AV_STOP_3

CFM	Outlet Velocity F/M	Static Pressure																							
		1.0'			2.0'			3.0'			4.0'			5.0'			6.0'			7.0'			8.0'		
		RPM	Bld. °	BHP	RPM	Bld. °	BHP	RPM	Bld. °	BHP	RPM	Bld. °	BHP	RPM	Bld. °	BHP	RPM	Bld. °	BHP	RPM	Bld. °	BHP	RPM	Bld. °	BHP
10,570	1,250	1,002	19°	3.20	1,372	16°	6.71	1,749	13°	10.89	1,936	13°	15.23	2,098	13°	19.86	2,073	16°	26.21	2,079	19°	35.60	2,075	22°	46.23
12,584	1,500	1,079	19°	3.82	1,456	16°	7.73	1,670	16°	12.15	1,857	16°	17.18	2,024	16°	22.79	2,038	19°	31.57	2,046	22°	41.45			
14,798	1,750	1,164	19°	4.55	1,549	16°	8.97	1,752	16°	13.61	1,935	16°	18.84	2,098	16°	24.56	2,117	19°	33.98	2,127	22°	44.35			
16,912	2,000	1,136	22°	5.27	1,486	19°	10.17	1,843	16°	15.37	2,016	16°	20.78	2,043	19°	28.75	2,084	22°	39.06						
19,026	2,250	1,119	25°	6.39	1,568	19°	11.52	1,759	19°	17.22	2,106	16°	23.08	2,104	19°	30.69	2,147	22°	41.53						
21,140	2,500	1,304	22°	7.34	1,511	22°	13.02	1,837	19°	19.08	2,003	19°	25.63	2,049	22°	34.90									
23,254	2,750	1,396	22°	8.72	1,583	22°	14.43	1,919	19°	21.12	2,078	19°	27.98	2,086	22°	36.56									
25,368	3,000	1,241	28°	10.15	1,659	22°	16.04	2,005	19°	23.34	1,988	22°	30.88	2,133	22°	38.76									
27,482	3,250	1,310	28°	11.69	1,743	22°	18.03	1,904	22°	25.47	2,057	22°	33.67												
29,596	3,500	1,362	28°	13.45	1,831	22°	20.39	1,978	22°	27.73	2,127	22°	36.44												
31,710	3,750	1,457	28°	15.45	1,922	22°	23.04	2,057	22°	30.28	2,034	25°	40.29												
33,824	4,000	1,534	28°	17.73	2,015	22°	26.00	2,141	22°	33.39	2,099	25°	43.57	2,092	28°	54.54									
35,938	4,250	1,613	28°	20.28	1,757	28°	28.79	2,042	25°	37.67	2,021	28°	48.01	2,142	28°	58.34									
38,052	4,500	1,467	34°	23.06	1,826	28°	31.82	2,117	25°	41.52	2,065	28°	51.93	2,101	31°	65.93									
40,166	4,750	1,532	34°	26.01	1,897	28°	35.15	2,031	28°	45.53	2,029	31°	57.81	2,066	34°	74.87									
42,280	5,000	1,598	34°	29.26	1,970	28°	38.80	2,097	28°	49.45	2,085	31°	62.11												
44,394	5,250	1,665	34°	32.81	2,044	28°	42.79	2,028	31°	54.77	2,144	31°	66.77												
46,508	5,500	1,733	34°	36.88	2,121	28°	47.20	2,091	31°	59.44	2,102	34°	74.93												
48,622	5,750	1,801	34°	40.89	1,920	34°	52.67	2,045	34°	66.04															
50,736	6,000	1,662	40°	45.37	1,982	34°	57.51	2,102	34°	71.16															

Performance certified is for installation type D – Ducted inlet, Ducted outlet. Performance ratings do not include the affects of appurtenances (accessories). Power rating (BHP) includes drive losses. The AMCA Certified Ratings Seal does not apply to Series 67. Air and Sound Performance Data is available in Hartzell ESP (Electronic Support Package). Please visit www.hartzellfan.com to request a copy.

To complete the model code for your selection, add the designation for the blade angle and motor name plate HP in the appropriate space. See page 2 for the complete Hartzell Model Code Explanation and example.

66---449AV_STOP_3 or 67---449AV_STOP_3

CFM	Outlet Velocity F/M	Static Pressure																							
		1.0"			2.0"			3.0"			4.0"			5.0"			6.0"			7.0"			8.0"		
		RPM	Bld. *	BHP	RPM	Bld. *	BHP	RPM	Bld. *	BHP	RPM	Bld. *	BHP	RPM	Bld. *	BHP	RPM	Bld. *	BHP	RPM	Bld. *	BHP	RPM	Bld. *	BHP
13,311	1,250	884	16*	4.18	1,206	13*	8.81	1,400	13*	14.18	1,563	13*	20.07	1,704	13*	26.37	1,825	13*	32.95	1,834	16*	43.97	1,833	19*	56.88
15,973	1,500	815	22*	4.97	1,173	16*	10.14	1,468	13*	15.96	1,632	13*	22.35	1,777	13*	29.22	1,908	13*	36.45	1,821	19*	52.06	1,912	19*	61.52
18,635	1,750	873	22*	5.89	1,245	16*	11.70	1,416	16*	17.98	1,700	13*	24.75	1,844	13*	32.08	1,866	16*	42.44	1,901	19*	56.64	1,907	22*	72.20
21,298	2,000	935	22*	7.02	1,128	22*	13.32	1,482	16*	20.07	1,630	16*	27.48	1,913	13*	35.15	1,910	16*	45.05	1,880	22*	65.66			
23,960	2,250	926	25*	8.32	1,182	22*	14.93	1,432	19*	22.62	1,694	16*	30.16	1,826	16*	38.57	1,863	19*	50.97						
26,622	2,500	989	25*	9.83	1,240	22*	16.86	1,391	22*	24.93	1,769	16*	33.46	1,889	16*	41.91	1,890	19*	53.25						
29,284	2,750	929	31*	11.49	1,302	22*	19.08	1,446	22*	27.38	1,580	22*	36.81	1,809	19*	46.13	1,859	22*	59.99						
31,946	3,000	981	31*	13.30	1,267	25*	21.60	1,505	22*	30.21	1,763	19*	40.78	1,874	19*	50.34	1,882	22*	62.54						
34,609	3,250	1,035	31*	15.38	1,326	25*	24.28	1,565	22*	33.41	1,687	22*	43.22	1,801	22*	53.97	1,913	22*	65.75						
37,271	3,500	1,090	31*	17.73	1,389	25*	27.33	1,512	25*	37.15	1,746	22*	47.09	1,855	22*	58.03									
39,933	3,750	1,147	31*	20.37	1,285	31*	30.64	1,569	25*	40.84	1,806	22*	51.39	1,914	22*	62.58	1,901	25*	77.87						
42,595	4,000	1,206	31*	23.33	1,337	31*	34.03	1,763	22*	45.38	1,870	22*	56.14	1,842	25*	68.97									
45,257	4,250	1,266	31*	26.63	1,389	31*	37.75	1,692	25*	49.50	1,793	25*	61.24	1,893	25*	74.00	1,885	28*	90.51						
47,920	4,500	1,326	31*	30.28	1,442	31*	41.83	1,585	31*	54.51	1,852	25*	66.52	1,851	28*	81.75	1,843	31*	97.90						
50,582	4,750	1,388	31*	34.31	1,497	31*	46.28	1,607	31*	59.42	1,914	25*	72.29	1,901	28*	87.55									
53,244	5,000	1,450	31*	38.74	1,553	31*	51.15	1,769	28*	65.56	1,755	31*	79.13	1,846	31*	94.42									
55,906	5,250	1,513	31*	43.58	1,610	31*	56.43	1,711	31*	70.40	1,807	31*	85.29												
58,568	5,500	1,576	31*	48.85	1,668	31*	62.15	1,764	31*	76.55	1,858	31*	91.69												
61,230	5,750	1,549	34*	55.62	1,727	31*	68.35	1,819	31*	83.16	1,910	31*	98.92												
63,893	6,000	1,704	31*	60.79	1,787	31*	75.03	1,874	31*	90.25															

66---499AV_STOP_3 or 67---499AV_STOP_3

CFM	Outlet Velocity F/M	Static Pressure																							
		1.0"			2.0"			3.0"			4.0"			5.0"			6.0"			7.0"			8.0"		
		RPM	Bld. *	BHP	RPM	Bld. *	BHP	RPM	Bld. *	BHP	RPM	Bld. *	BHP	RPM	Bld. *	BHP	RPM	Bld. *	BHP	RPM	Bld. *	BHP	RPM	Bld. *	BHP
16,579	1,250	800	19*	5.02	1,095	16*	10.52	1,396	13*	17.08	1,546	13*	23.88	1,675	13*	31.14	1,655	16*	41.11	1,680	19*	55.83	1,857	22*	72.51
19,895	1,500	861	19*	6.00	1,162	16*	12.12	1,334	16*	19.06	1,483	16*	26.97	1,616	16*	35.75	1,628	19*	49.51	1,633	22*	65.01			
23,211	1,750	930	19*	7.14	1,237	16*	14.07	1,399	16*	21.35	1,545	16*	29.55	1,675	16*	38.52	1,690	19*	53.29	1,698	22*	69.56			
26,527	2,000	907	22*	8.27	1,187	19*	15.95	1,471	16*	24.11	1,610	16*	32.60	1,831	19*	45.10	1,864	22*	61.26						
29,842	2,250	971	22*	9.67	1,252	19*	18.07	1,405	19*	27.02	1,681	16*	36.20	1,680	19*	48.13	1,715	22*	65.14						
33,158	2,500	1,041	22*	11.51	1,207	22*	20.42	1,466	19*	29.92	1,599	19*	40.20	1,636	22*	54.73									
36,474	2,750	1,114	22*	13.67	1,264	22*	22.63	1,532	19*	33.13	1,659	19*	43.88	1,666	22*	57.34									
39,790	3,000	991	28*	15.92	1,325	22*	25.16	1,601	19*	36.62	1,588	22*	48.43	1,703	22*	60.60									
43,106	3,250	1,046	28*	18.34	1,391	22*	28.28	1,520	22*	39.94	1,643	22*	52.81												
46,422	3,500	1,104	28*	21.09	1,462	22*	31.98	1,579	22*	43.49	1,699	22*	57.16												
49,737	3,750	1,163	28*	24.23	1,535	22*	36.14	1,642	22*	47.50	1,624	25*	63.19												
53,053	4,000	1,225	28*	27.81	1,609	22*	40.78	1,710	22*	52.37	1,676	25*	68.34	1,670	28*	85.54									
56,369	4,250	1,288	28*	31.81	1,403	28*	45.16	1,631	25*	59.40	1,614	28*	75.30	1,710	28*	91.51									
59,685	4,500	1,171	34*	36.18	1,458	28*	49.91	1,680	25*	65.13	1,664	28*	81.45												
63,001	4,750	1,223	34*	40.80	1,515	28*	55.13	1,622	28*	71.42	1,620	31*	90.67												
66,317	5,000	1,276	34*	45.89	1,573	28*	60.86	1,674	28*	77.56	1,665	31*	97.43												
69,632	5,250	1,330	34*	51.46	1,632	28*	67.12	1,619	31*	85.90															
72,948	5,500	1,384	34*	57.54	1,694	28*	74.03	1,670	31*	93.24															
76,264	5,750	1,438	34*	64.14	1,533	34*	82.81																		
79,580	6,000	1,327	40*	71.17	1,583	34*	90.21																		

Performance certified is for installation type D – Ducted inlet, Ducted outlet. Performance ratings do not include the affects of appurtenances (accessories). Power rating (BHP) includes drive losses. The AMCA Certified Ratings Seal does not apply to Series 67. Air and Sound Performance Data is available in Hartzell ESP (Electronic Support Package). Please visit www.hartzellfan.com to request a copy.

To complete the model code for your selection, add the designation for the blade angle and motor name plate HP in the appropriate space. See page 2 for the complete Hartzell Model Code Explanation and example.



66---579AV_STOP_3 or 67---579AV_STOP_3

CFM	Outlet Velocity F/M	Static Pressure																							
		1.0'			2.0'			3.0'			4.0'			5.0'			6.0'			7.0'			8.0'		
		RPM	Bld. °	BHP	RPM	Bld. °	BHP	RPM	Bld. °	BHP	RPM	Bld. °	BHP	RPM	Bld. °	BHP	RPM	Bld. °	BHP	RPM	Bld. °	BHP	RPM	Bld. °	BHP
22,269	1,250	684	16°	7.00	932	13°	14.75	1,082	13°	23.72	1,209	13°	33.58	1,317	13°	44.11	1,411	13°	55.12	1,418	16°	73.56	1,417	19°	95.16
26,723	1,500	830	22°	8.32	907	16°	16.96	1,135	13°	26.70	1,262	13°	37.39	1,374	13°	48.88	1,473	13°	60.99	1,408	19°	87.14	1,478	19°	102.92
31,177	1,750	675	22°	9.85	963	16°	19.58	1,094	16°	30.07	1,314	13°	41.41	1,426	13°	53.67	1,443	16°	71.00	1,469	19°	94.76	1,474	22°	120.80
35,631	2,000	723	22°	11.74	872	22°	22.29	1,145	16°	33.56	1,260	16°	45.98	1,479	13°	58.80	1,476	16°	75.37	1,453	22°	109.84			
40,085	2,250	716	25°	13.91	914	22°	24.99	1,107	19°	37.85	1,309	16°	50.46	1,411	16°	64.53	1,440	19°	85.27						
44,539	2,500	765	25°	16.44	959	22°	28.20	1,076	22°	41.70	1,368	16°	55.97	1,460	16°	70.12	1,461	19°	89.09						
48,993	2,750	718	31°	19.22	1,007	22°	31.93	1,118	22°	45.80	1,221	22°	61.56	1,399	19°	77.18	1,437	22°	100.36						
53,446	3,000	758	31°	22.26	979	25°	36.14	1,163	22°	50.54	1,261	22°	66.56	1,449	19°	84.21	1,455	22°	104.62						
57,900	3,250	800	31°	25.73	1,025	25°	40.63	1,210	22°	55.90	1,304	22°	72.30	1,392	22°	90.29	1,479	22°	110.01						
62,354	3,500	843	31°	29.65	1,074	25°	45.72	1,259	22°	61.91	1,350	22°	78.78	1,434	22°	97.08									
66,808	3,750	887	31°	34.08	994	31°	51.26	1,213	25°	68.33	1,397	22°	85.96	1,479	22°	104.70	1,469	25°	130.28						
71,262	4,000	932	31°	39.03	1,033	31°	56.93	1,260	25°	75.20	1,446	22°	93.92	1,424	25°	115.39									
75,716	4,250	978	31°	44.55	1,148	28°	64.26	1,308	25°	82.81	1,386	25°	102.46	1,464	25°	123.80	1,465	28°	151.43						
80,170	4,500	1,025	31°	50.66	1,115	31°	69.97	1,202	31°	91.20	1,432	25°	111.29	1,431	28°	136.77	1,425	31°	163.78						
84,623	4,750	1,018	34°	58.89	1,157	31°	77.43	1,242	31°	99.41	1,480	25°	120.95	1,470	28°	146.48	1,459	31°	173.93						
89,077	5,000	1,121	31°	64.81	1,201	31°	85.57	1,282	31°	108.24	1,357	31°	132.38	1,428	31°	157.96									
93,531	5,250	1,170	31°	72.90	1,245	31°	94.41	1,322	31°	117.78	1,397	31°	142.69	1,465	31°	168.88									
97,985	5,500	1,219	31°	81.73	1,290	31°	103.99	1,364	31°	128.06	1,437	31°	153.74	1,450	34°	191.06									
102,439	5,750	1,288	31°	91.32	1,335	31°	114.35	1,406	31°	138.13	1,476	31°	165.50												
106,893	6,000	1,317	31°	101.71	1,382	31°	125.52	1,449	31°	151.01	1,457	34°	186.29												

66---639AV_STOP_3 or 67---639AV_STOP_3

CFM	Outlet Velocity F/M	Static Pressure																							
		1.0'			2.0'			3.0'			4.0'			5.0'			6.0'			7.0'			8.0'		
		RPM	Bld. °	BHP	RPM	Bld. °	BHP	RPM	Bld. °	BHP	RPM	Bld. °	BHP	RPM	Bld. °	BHP	RPM	Bld. °	BHP	RPM	Bld. °	BHP	RPM	Bld. °	BHP
27,081	1,250	626	19°	8.21	857	16°	17.18	1,093	13°	27.90	1,210	13°	39.03	1,311	13°	50.87	1,295	16°	67.16	1,299	19°	91.20	1,296	22°	118.45
32,497	1,500	621	22°	9.89	910	16°	19.80	1,044	16°	31.13	1,160	16°	44.05	1,264	16°	58.40	1,274	19°	80.88	1,278	22°	106.19			
37,913	1,750	727	19°	11.66	968	16°	22.98	1,095	16°	34.87	1,209	16°	48.26	1,311	16°	62.93	1,322	19°	87.05	1,329	22°	113.62			
43,330	2,000	710	22°	13.50	929	19°	26.06	1,151	16°	39.39	1,260	16°	53.24	1,276	19°	73.67	1,302	22°	100.07						
48,746	2,250	760	22°	15.80	980	19°	29.52	1,099	19°	44.13	1,316	16°	59.14	1,314	19°	78.62	1,342	22°	106.40						
54,162	2,500	814	22°	18.79	944	22°	33.35	1,147	19°	48.88	1,251	19°	65.66	1,280	22°	89.40									
59,578	2,750	872	22°	22.33	989	22°	36.96	1,199	19°	54.12	1,298	19°	71.58	1,303	22°	93.66									
64,994	3,000	775	28°	26.00	1,037	22°	41.10	1,253	19°	59.81	1,242	22°	79.11	1,333	22°	99.31									
70,411	3,250	819	28°	29.95	1,089	22°	46.20	1,189	22°	65.24	1,285	22°	86.27												
75,827	3,500	864	28°	34.46	1,144	22°	52.24	1,236	22°	71.04	1,329	22°	93.37												
81,243	3,750	910	28°	39.58	1,201	22°	59.04	1,285	22°	77.58	1,271	25°	103.22												
86,659	4,000	959	28°	45.43	1,259	22°	66.61	1,336	22°	85.54	1,312	25°	111.62	1,307	28°	139.72									
92,075	4,250	1,008	28°	51.97	1,098	28°	73.77	1,276	25°	97.03	1,263	28°	122.99	1,338	28°	149.48									
97,492	4,500	916	34°	59.09	1,141	28°	81.53	1,323	25°	106.38	1,302	28°	133.05	1,313	31°	168.93									
102,908	4,750	957	34°	66.64	1,185	28°	90.06	1,268	28°	116.66	1,267	31°	148.11	1,290	34°	191.82									
108,324	5,000	998	34°	74.96	1,231	28°	99.40	1,310	28°	128.69	1,303	31°	159.14												
113,740	5,250	1,040	34°	84.06	1,277	28°	109.63	1,267	31°	140.32	1,339	31°	171.07												
119,156	5,500	1,083	34°	93.98	1,325	28°	120.92	1,306	31°	152.30	1,313	34°	191.97												
124,573	5,750	1,125	34°	104.77	1,199	34°	134.94	1,278	34°	169.20															
129,989	6,000	1,039	40°	116.25	1,238	34°	147.36	1,313	34°	182.37															

Performance certified is for installation type D – Ducted inlet, Ducted outlet. Performance ratings do not include the affects of appurtenances (accessories). Power rating (BHP) includes drive losses. The AMCA Certified Ratings Seal does not apply to Series 67. Air and Sound Performance Data is available in Hartzell ESP (Electronic Support Package). Please visit www.hartzellfan.com to request a copy.

To complete the model code for your selection, add the designation for the blade angle and motor name plate HP in the appropriate space. See page 2 for the complete Hartzell Model Code Explanation and example.



66---71-AV_STOP_3 or 67---719AV_STOP_3

CFM	Outlet Velocity F/M	Static Pressure																							
		1.0"			2.0"			3.0"			4.0"			5.0"			6.0"			7.0"			8.0"		
		RPM	Bld. *	BHP	RPM	Bld. *	BHP	RPM	Bld. *	BHP	RPM	Bld. *	BHP	RPM	Bld. *	BHP	RPM	Bld. *	BHP	RPM	Bld. *	BHP	RPM	Bld. *	BHP
34,368	1,250	550	16*	10.80	750	13*	22.76	871	13*	36.61	973	13*	51.83	1,060	13*	68.08	1,136	13*	85.07	1,141	16*	113.53	1,141	19*	146.86
41,242	1,500	507	22*	12.84	730	16*	26.17	913	13*	41.20	1,016	13*	57.71	1,106	13*	75.43	1,186	13*	94.12	1,133	19*	134.48	1,190	19*	158.84
48,115	1,750	543	22*	15.20	714	19*	30.31	881	16*	46.41	1,058	13*	63.90	1,147	13*	82.82	1,161	16*	109.57	1,183	19*	146.24	1,187	22*	185.42
54,989	2,000	582	22*	18.12	702	22*	34.40	922	16*	51.82	1,014	16*	70.96	1,191	13*	90.75	1,186	16*	116.32	1,170	22*	169.52			
61,862	2,250	576	25*	21.47	735	22*	38.56	891	19*	58.41	1,054	16*	77.87	1,136	16*	99.58	1,159	19*	131.60						
68,736	2,500	615	25*	25.37	721	25*	44.46	866	22*	64.36	1,101	16*	86.38	1,176	16*	108.22	1,176	19*	137.49						
75,610	2,750	578	31*	29.86	753	25*	49.71	900	22*	70.68	983	22*	95.03	1,126	19*	119.12	1,157	22*	154.89						
82,483	3,000	611	31*	34.35	851	22*	55.65	936	22*	77.99	1,015	22*	102.72	1,166	19*	129.96	1,171	22*	161.47						
89,337	3,250	644	31*	39.70	825	25*	62.70	974	22*	86.27	1,050	22*	111.59	1,121	22*	139.35	1,191	22*	169.77						
96,230	3,500	678	31*	45.77	865	25*	70.56	1,013	22*	95.55	1,087	22*	121.58	1,155	22*	149.82									
103,104	3,750	714	31*	52.59	906	25*	79.43	976	25*	105.45	1,124	22*	132.69	1,191	22*	161.58									
109,977	4,000	750	31*	60.23	832	31*	87.66	1,014	25*	116.05	1,164	22*	144.85	1,146	25*	178.07									
116,851	4,250	750	34*	70.84	864	31*	97.46	1,053	25*	127.60	1,116	25*	158.12	1,176	25*	191.06									
123,725	4,500	825	31*	78.19	898	31*	107.99	968	31*	140.74	1,153	25*	171.76												
130,598	4,750	864	31*	88.59	932	31*	119.50	1,000	31*	153.42	1,191	25*	186.65												
137,472	5,000	903	31*	100.02	967	31*	132.06	1,032	31*	167.04															
144,345	5,250	942	31*	112.51	1,002	31*	145.70	1,085	31*	181.76															
151,219	5,500	981	31*	126.13	1,038	31*	160.48	1,098	31*	197.64															
158,093	5,750	1,021	31*	140.94	1,075	31*	176.47																		
164,966	6,000	1,060	31*	156.95	1,112	31*	193.71																		

66---799AV_STOP_3 or 67---799AV_STOP_3

CFM	Outlet Velocity F/M	Static Pressure																								
		1.0"			2.0"			3.0"			4.0"			5.0"			6.0"			7.0"			8.0"			
		RPM	Bld. *	BHP	RPM	Bld. *	BHP	RPM	Bld. *	BHP	RPM	Bld. *	BHP	RPM	Bld. *	BHP	RPM	Bld. *	BHP	RPM	Bld. *	BHP	RPM	Bld. *	BHP	
42,415	1,250	500	19*	12.85	685	16*	26.91	873	13*	43.70	966	13*	61.12	1,047	13*	79.68	1,035	16*	105.18	1,038	19*	142.84	1,036	22*	185.52	
50,899	1,500	538	19*	15.34	727	16*	31.01	834	16*	48.76	927	16*	69.00	1,010	16*	91.46	1,018	19*	126.67	1,021	22*	166.33				
59,382	1,750	561	19*	18.26	705	19*	36.05	875	16*	54.62	966	16*	75.59	1,047	16*	98.56	1,057	19*	136.34	1,062	22*	177.96				
67,865	2,000	567	22*	21.15	742	19*	40.82	920	16*	61.69	1,007	16*	83.39	1,020	19*	115.38	1,040	22*	156.73							
76,348	2,250	607	22*	24.74	719	22*	46.66	878	19*	69.12	1,051	16*	92.62	1,050	19*	123.15	1,072	22*	166.65							
84,831	2,500	651	22*	29.44	754	22*	52.24	917	19*	76.56	1,000	19*	102.84	1,023	22*	140.03										
93,314	2,750	697	22*	34.98	872	19*	59.18	958	19*	84.76	1,037	19*	112.27	1,042	22*	146.70										
101,797	3,000	620	28*	40.73	828	22*	64.37	1,001	19*	93.67	993	22*	123.91	1,065	22*	155.55										
110,280	3,250	654	28*	46.91	870	22*	72.35	950	22*	102.19	1,027	22*	135.11													
118,763	3,500	690	28*	53.96	914	22*	81.82	987	22*	111.26	1,062	22*	146.24													
127,246	3,750	727	28*	62.00	959	22*	92.47	1,027	22*	121.51	1,018	25*	161.86													
135,730	4,000	766	28*	71.15	1,006	22*	104.33	1,069	22*	133.97	1,048	25*	174.83													
144,213	4,250	701	34*	81.90	877	28*	115.54	1,020	25*	151.97	1,009	28*	192.64													
152,696	4,500	732	34*	92.56	912	26*	127.69	1,057	25*	166.61																
161,179	4,750	765	34*	104.38	947	26*	141.05	1,014	28*	182.72																
169,662	5,000	713	40*	118.12	983	28*	155.69	1,047	28*	198.43																
178,145	5,250	831	34*	131.65	1,020	28*	171.71																			
186,628	5,500	865	34*	147.20	1,059	28*	189.40																			
195,111	5,750	899	34*	164.09																						
203,594	6,000	934	34*	182.39																						

Performance certified is for installation type D – Ducted inlet, Ducted outlet. Performance ratings do not include the affects of appurtenances (accessories). Power rating (BHP) includes drive losses. The AMCA Certified Ratings Seal does not apply to Series 67. Air and Sound Performance Data is available in Hartzell ESP (Electronic Support Package). Please visit www.hartzellfan.com to request a copy.

To complete the model code for your selection, add the designation for the blade angle and motor name plate HP in the appropriate space. See page 2 for the complete Hartzell Model Code Explanation and example.



Accessories

Companion Flanges

Drilled to fit the flanges of the blower; allows easy installation.



Access Door

For maintenance of the internal parts of vaneaxial blowers. The door is gasketed and bolted. Series 65 and 67 only.

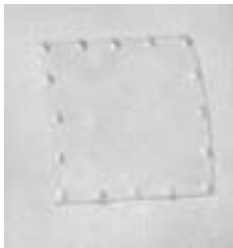

Inlet and Outlet Cones

Available for adapting to larger diameters, resulting in a static pressure regain. See page 6.

Inlet/Outlet Cone

Minimizes entrance losses for optimum air flow. Cones are flanged and drilled to match fan casing companion flanges.



Mounting Feet

Bolted to the inlet and discharge flanges, mounting feet allow positioning of the vaneaxial blower on the floor. Ceiling, wall or platform. Can be used with vibration isolators.



Ceiling Suspension

Side mounting brackets can be used with vibration isolators. Shown with supports for horizontal mount. Also available for vertical mount.



Special Construction/Coatings

Several coatings are available including high-solids, corrosion resistant epoxy and inorganic zinc.

Guard

Heavy duty spiral ring guard offers protection on intake or discharge side.



CAUTION: The drive assembly or the periphery of the blades of a fan less than seven (7) feet above the floor or working level must be guarded to be in accordance with OSHA regulations.

SAFETY ACCESSORIES, APPLICATION AND USE WARNING

The safe application and use of equipment supplied by Hartzell Fan, Inc. is the responsibility of the installer, the user, the owner, and the employer. Since the application and use of its equipment can vary greatly, Hartzell Fan, Inc. offers various product types, optional safety accessories, and sound performance data per laboratory tests. Hartzell Fan, Inc. sells its equipment with and without safety accessories, and accordingly, it can supply such safety accessories only upon receipt of an order. The need for safety accessories will frequently depend upon the type of system, fan location and operating procedures being employed. The proper protective safety accessories to meet company standards, local codes, and the requirements of the Occupational Safety and Health Act must be determined by the user since safety requirements vary depending on the location and use of the equipment. If applicable local conditions, standards, codes or OSHA rules require the addition of the safety accessories, the user should specify and obtain the required safety accessories from Hartzell Fan, Inc. and should not allow the operation of the equipment without them.

Owners, employers, users and installers should read "RECOMMENDED SAFETY PRACTICES FOR USERS AND INSTALLERS OF INDUSTRIAL AND COMMERCIAL FANS" published by the Air Movement and Control Association International, Inc., 30 West University Drive, Arlington Heights, Illinois 60004. A copy of this publication is enclosed with each fan shipped from Hartzell Fan, Inc., and is available upon request at Hartzell's office in Piqua, Ohio 45356.

Please contact Hartzell Fan, Inc. or your local Hartzell representative for more information on product types, safety accessories, and sound performance estimates. Remember, the selection of safety accessories and the safe application and use of equipment supplied by Hartzell Fan, Inc. is **your** responsibility.



Combination Motor Cover and Belt Guard

Covers are vented. Offers weather protection and guarding of the drive. Specify direction of airflow when ordering motor cover.

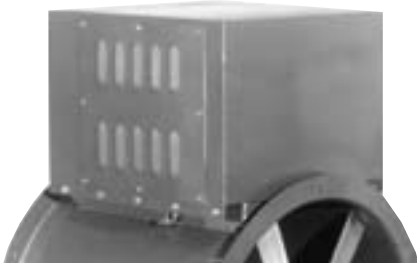

Belt Guard

Covers motor sheave and belts outside fan housing.



Shaft Seal and Slinger

A neoprene shaft seal and slinger are available for belt drive units. A shaft seal does not make the inner cylinder gas tight.

Inlet Control Damper

Provides accurate volume control without significantly reducing fan performance. Assembly bolts to fan flange.

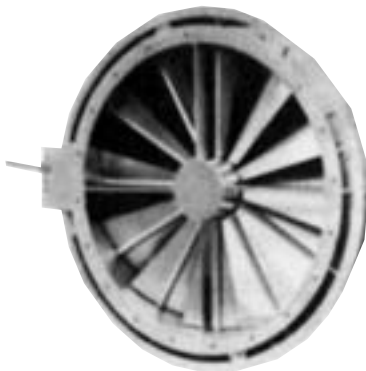

High Temperature Construction

Arrangement #4 – Standard fan configuration is furnished with totally enclosed air-over motors suitable for maximum air temperature of 104° F. Special motors are available for higher temperature applications.

Arrangement #9 — Standard fan configuration is suitable for a maximum temperature of 180° F. Unit can be modified for a temperatures up to 350° F.

Roof Mounted

Together with a stack cap and panel, the Adjustable Pitch Vaneaxial Fans can be mounted as roof exhausters. In combination, these three units provide a roof exhauster unit with high static pressure capabilities. Back draft dampers offer weatherproof closure for vertical air discharge.

For performance, refer to the appropriate Fan Rating Table, or Performance Curve, allowing 1/8" SP resistance for the stack cap. See page 4 for CFM limits.



Sound Muffler

This sound attenuative device is a simple lined tube that can be used on either the intake or exhaust side of a Vaneaxial Blower to reduce the noise. It cannot be used in wet atmosphere or with air velocities over 5000 FPM or above 250°F. in airstream. The resistance to airflow is negligible since the internal surface is fairly smooth and the internal diameter of the muffler is the same as the fan with no internal obstruction to impede airflow. In general, the muffler should be mounted between the fan and the area of concern (the listener.)

If both the intake and exhaust of the fan are critical, use a muffler on both sides of the fan.

The outstanding features of this muffler are:

- The typical attenuation for fans with discharge velocities from 1500-3000 FPM is approximately as follows for one muffler:

Band	1	2	3	4	5	6	7	8
dB Attenuation	0	1	3	10	13	12	10	8

- For one muffler the reduction in some value is approximately 35%. With a muffler on both intake and exhaust, the tones are reduced approximately 50%.
- There is no appreciable static pressure loss when one or two mufflers are inserted into a duct system.
- The mounting flanges match the corresponding fan flanges and are drilled for easy attachment. By using flexible connections between fan and muffler, the sound attenuation is helped, particularly in the lower bands.
- The absorbent material has a black rubberized surface next to the airstream which prevents erosion up to 5000 FPM velocity, and is held in place with an expanded metal liner.



Hartzell Warranty

LIMITED WARRANTIES

Hartzell represents to Buyer that any goods to be delivered hereunder will be produced in compliance with the requirements of the Fair Labor Standards Act of 1938 as amended.

Hartzell also warrants to Buyer its goods to be free from defects in workmanship and material under normal use and service for one (1) year after tender of delivery by Hartzell, plus six months allowance for shipment to approved stocking dealers and distributors. No warranty extends to future performance of goods and any claims for breach of warranty or otherwise accrues upon tender of delivery. The foregoing constitute Hartzell's sole and exclusive warranties and are in lieu of all other warranties, whether written, oral, express, implied or statutory.

LIMITATION OF LIABILITY FOR BREACH OF WARRANTY

Hartzell's obligation for any breach of warranty is limited to repairing or replacing, at its option, without cost to Buyer at its factory any goods which shall, within such a warranty period, be returned to it with transportation charges prepaid, and which its examination shall disclose to its satisfaction to have been defective. Any request for repair or replacement should be directed to Hartzell Fan, Inc., P.O. Box 919, Piqua, Ohio 45356. Hartzell will not pay for any repairs made outside its factory without its prior written consent. This does not apply to any such Hartzell goods which have failed as a result of faulty installation or abuse, or incorrect electrical connections or alterations, made by others, or use under abnormal operating conditions or misapplication of the goods.

LIMITATION OF LIABILITY

To the extent the above limitation of liability for breach of warranty is not applicable, the liability of Hartzell on any claim of any kind, including negligence, for any loss or damage arising out of or connected with, or resulting from the sale and purchase of the goods or services covered by these Terms and Conditions of Sale or from the performance or breach of any contract pertaining to such sale or purchase or from the design manufacture, sale, delivery, resale, installation, technical direction installation, inspection repair, operation or use of any goods or services covered by these Terms and Conditions shall, in no case exceed the price allocable to the goods or services which gave rise to the claim and shall terminate one year after tender of delivery of said goods or services, plus six months allowance for shipment to approved stocking dealers and distributors. In no event will Hartzell be responsible or liable for any labor or other incidental costs associated with the removal or replacement of defective products or materials.

In no event whether as a result of breach of contract, or warranty or alleged negligence, defects, incorrect advice or other causes, shall Hartzell be liable for special or consequential damages, including, but not limited to, loss of profits or revenue, loss of use of the equipment or any associated equipment, cost of substitute equipment, facilities or services, down time costs, or claims of customers of the Buyer for such damages. Hartzell neither assumes nor authorizes any person to assume for it any other liability in connection with the sale of its goods or services.

NO IMPLIED WARRANTIES OF MERCHANTABILITY OR FITNESS

HARTZELL DOES NOT WARRANT THAT SAID GOODS ARE OF MERCHANTABILITY QUALITY OR THAT THEY ARE FIT FOR ANY PARTICULAR PURPOSE. THERE IS NO IMPLIED WARRANTY OF MERCHANTABILITY AND THERE IS NO IMPLIED WARRANTY OF FITNESS.



Propeller Fans



Cooling Tower &
Heat Exchanger Fans



Duct Fans



Duct Axial Fans



Vaneaxial Blowers



Cool Blast & Utility Fans



Steel Centrifugal Blowers



Roof Ventilators –
Steel & Fiberglass



Heating Equipment –
Gas & Steam



Fiberglass
Axial Flow Fans



Fiberglass Centrifugal
Blowers



Marine –
Mine Duty Blowers

Hartzell Fan, Inc., Piqua, Ohio 45356 • Plants in Piqua, Ohio and Portland, Indiana.